



Redes IP

Redes de Comunicações 1

**Licenciatura em Engenharia de Computadores e
Informática**

DETI-UA, 2023/2024

Propriedades de Rede de um PC

SSID:	MEA-CASA
Protocol:	Wi-Fi 6 (802.11ax)
Security type:	WPA2-Personal
Manufacturer:	Intel Corporation
Description:	Intel(R) Wi-Fi 6 AX201 160MHz
Driver version:	22.240.0.6
Network band:	5 GHz
Network channel:	100
Link speed (Receive/Transmit):	1201/29 (Mbps)
IPv6 address:	2001:8a0:de54:b500:baca:b795:e5e5:96e
Link-local IPv6 address:	fe80::161a:abb7:d9de:a76%9
IPv4 address:	192.168.1.82 ←
IPv4 DNS servers:	192.168.1.254 (Unencrypted)
Physical address (MAC):	20-C1-9B-DF-21-22

Notação decimal dos endereços IP

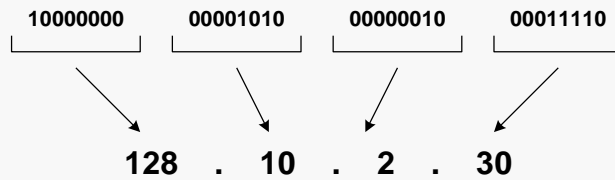

Classe	menor endereço	maior endereço
A	1.0.0.0	126.0.0.0
B	128.0.0.0	191.255.0.0
C	192.0.0.0	223.255.255.0
D	224.0.0.0	239.255.255.255
E	240.0.0.0	255.255.255.254

IP address notation

An IP address is represented by four numbers, separated by dots. Each number is the decimal representation of the corresponding byte.

Taking into consideration the special IP addresses (presented in the last slide) and the decimal notation representation, the above table shows the lowest and the highest addresses of each IP address class.

Máscaras

- Inicialmente os endereços IP tinham fronteiras fixas, sendo a fronteira definida a partir dos primeiros bits do campo de endereço; é o caso dos endereços de classe A, B e C
- Depois passaram a ter fronteiras flexíveis, sendo estas definidas a partir de uma máscara
- A máscara é utilizada para separar a parte de rede da parte de host dos endereços

	decimal		binário		
endereço IP	10.	0.0.1	00001010	00000000	00000000 00000001
máscara	255.	0.0.0	11111111	00000000	00000000 00000000
	←	→	←	→	
	rede	host	rede	host	

IP address masks (or netmasks)

Initially, the sizes of the netid and hostid parts of an unicast address were fixed and given by the definition of its class. Soon it was realized that the number of addresses of class A subnets were too large and the number of addresses of class C subnets were too small (at least for many situations).

Meanwhile, a more flexible way was adopted to define the netid and hostid parts of a unicast address, which is based on a mask (or netmask) composed also by four bytes and represented also in decimal notation. The netmask is always composed by a sequence of 1 bits and, then, a sequence of 0 bits. The 1 bits define the netid part of the address and the 0 bits define the hostid part of the address.

IMPORTANT: Besides enabling the choice of the appropriate size of netid and hostid parts, each host uses the netmask to determine the IP address of the subnet where it is attached to by making a bitwise 'and' operation between its IP address and the netmask.

Endereçamento IP - classes de endereços

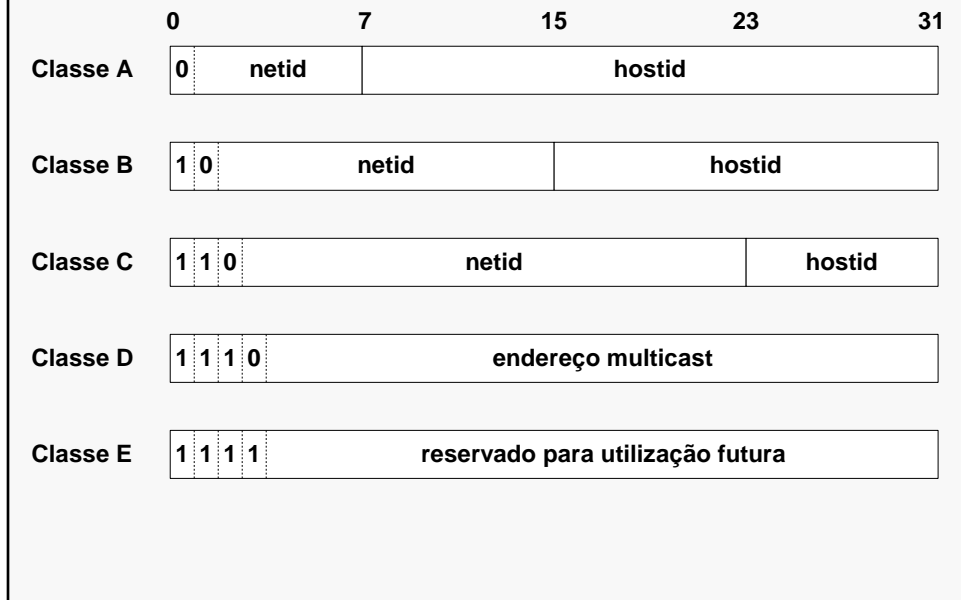

IP addressing

In order to communicate, each terminal host running the IP protocol must have an IP address. IP addresses (in the IP version 4, or IPv4 for short) are composed by 4 bytes and are classified in 5 different classes.

The addresses that can be assigned to terminal hosts are classified in classes A, B and C. These addresses are said to be unicast addresses since they are used for unicast communications (communications destined to a single host). Unicast addresses are structured in two parts: (i) a netid part, which identifies the IP subnet and (ii) a hostid part, which identifies the host within the IP subnet.

If the first bit (the most significant bit) is 0, the IP address belongs to class A and the netid part is defined by the first byte of the address. If the first two bits are 10, the IP address belongs to class B and the netid part is defined by the first two bytes of the address. If the first three bits are 110, the IP address belongs to class C and the netid part is defined by the first three bytes of the address.

Besides the unicast address classes, there are two additional classes. Class D addresses start with the first four bits 1110 and are used to multicast communications (communications destined to multiple hosts). Finally, class E addresses start with the first four bits 1111 and are reserved for future utilization.

Divisão do espaço de endereçamento unicast

Classe	# bits no prefixo	# máximo de redes	# bits no sufixo	# máximo de hosts por rede
A	7	128	24	16,777,216
B	14	16,384	16	65,536
C	21	2,097,152	8	256

NOTA: Nem todos os possíveis endereços podem ser usados!

Unicast addressing space division

The number of bits on each part of the unicast addresses define the total number of combinations for subnets and hosts on each subnet.

A class A address has 7 bits to define the netid (resulting in a total number of 128 combinations) and 24 bits to define the hostid (resulting in a total of 16777216 combinations).

A class B address has 14 bits to define the netid (resulting in a total number of 16,384 combinations) and 16 bits to define the hostid (resulting in a total of 65536 combinations).

A class C address has 21 bits to define the netid (resulting in a total number of 2097152 combinations) and 8 bits to define the hostid (resulting in a total of 256 combinations).

NOTE: Not all combinations are available to define the netid and the hostid since some combinations have special meanings (some of them shown in the next slide).

Endereços IP especiais

tudo 0s	ESTE HOST ¹
tudo 0s	host
host NESTA REDE ¹	
tudo 1s	BROADCAST LOCAL ²
net	tudo 1s
BROADCAST DIRIGIDO PARA net ²	
127	qualquer (em geral 1)
LOOPBACK ³	
net	tudo 0s
ESTA net ⁴	

¹ Permitido apenas na inicialização; nunca é endereço destino válido

² Nunca é endereço origem válido

³ Nunca deve aparecer na rede

⁴ Reservado para designar a rede

Special IP addresses

- The address composed by all bits equal to 0 represents the host that is using it. It is allowed only on host initialization and cannot be used as a destination address.
- The address with the netid part composed by all bits equal to 0 represents the host (defined by the hostid part) on the local subnet. It cannot be used as a destination address.
- The address composed by all bits equal to 1 represents the local broadcast address. It is used as a destination address to send information to all hosts of the local subnet and cannot be used as a source address.
- The address with the hostid part composed by all bits equal to 1 represents the broadcast address of the subnet defined by the netid part. It is used as a destination address to send information to all hosts of a remote subnet and cannot be used as a source address.
- Any class A address starting by 01111111 (in decimal notation, 127) is a loopback address. It is used as a destination address by a host to send information to its own interface (i.e., for host internal communication) and cannot be used to send information to the network.
- The address with the hostid part composed by all bits equal to 0 represents the subnet defined by the netid part.

Exemplo – endereçamento IP

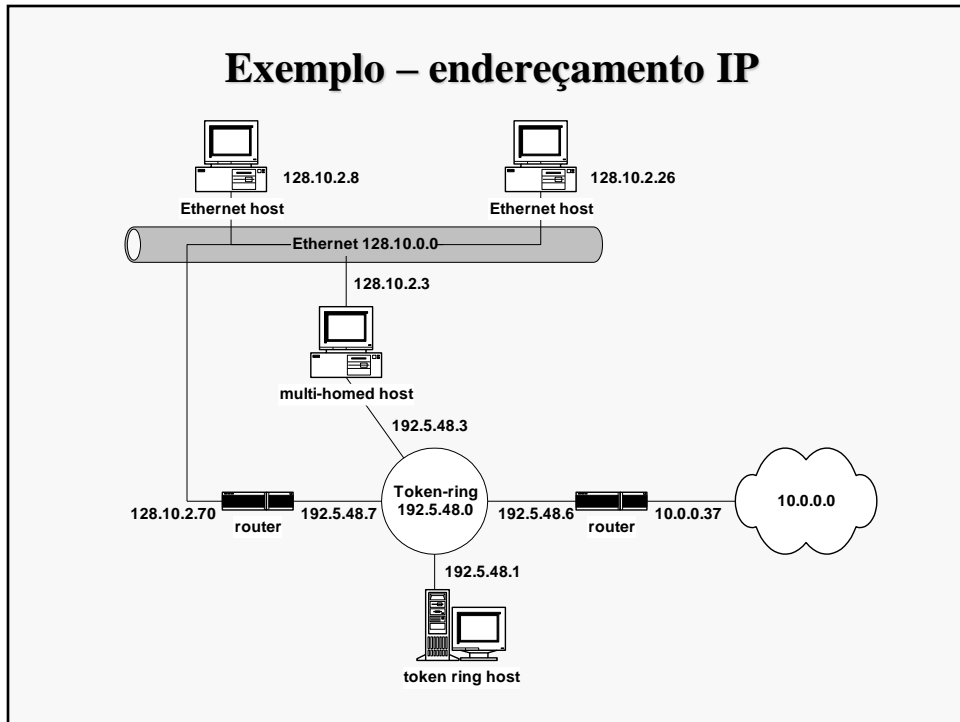

IP address assignment - example

Consider the above example of a network composed by physical networks (based on different technologies) and hosts connected to them. When assigning IP addresses to each network interface, the following rules must be obeyed:

- All network interfaces attached to the same physical network must have the same netid part and different hostid parts.
- All network interfaces attached to different physical networks must have different netid parts.

In this way, each host has a very simple way to determine if a destination host (defined by an IP address) is or is not in its own physical network: if the netid part of the IP destination address is equal to the netid part of its own IP address, the destination host is in the same physical network and the origin host can send the information directly to the destination host.

In the above example, we can distinguish three types of hosts:

Single-homed hosts – hosts with a single network interface.

Multi-homed hosts – hosts with more than one network interface; multi-homed hosts do not forward information received from one incoming network interface towards an outgoing network interface.

Routers – like multi-homed hosts, routers are hosts with more than one network interface; unlike multi-homed hosts, routers can forward information received from one incoming network interface towards an outgoing network interface.

Formato do datagrama IP

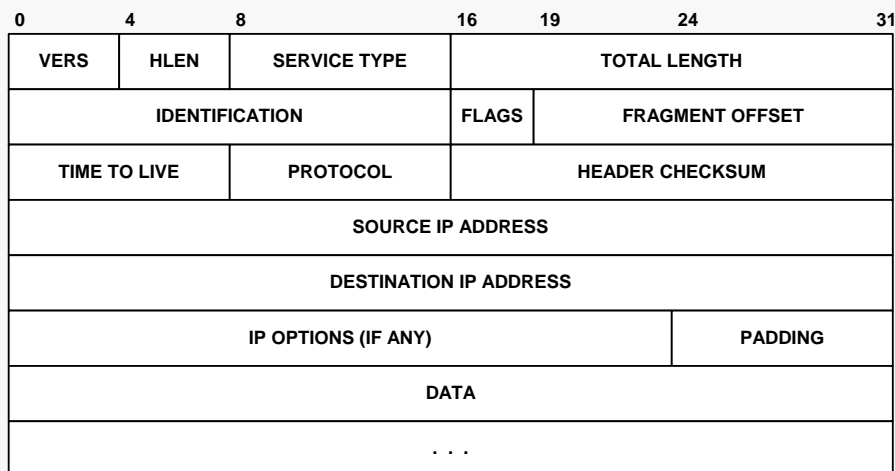

IP datagram format

An IP datagram is composed by an IP header field and a data field (where data is transported). The IP header has several mandatory fields with a total size of 20 bytes. The last two mandatory fields are the source and the destination IP addresses (obviously, each one with 4 bytes of size). The meaning of the other mandatory fields is explained in the next slides.

The IP header can have option fields. If there are option fields, the header size must be a multiple of 4 bytes (padding bytes are inserted, if required). Therefore, the IP header size can be 20, 24, 28, 32, and so on...

Campos do Datagrama IPv4

- **Version** (4 bits) – versão do protocolo IP (atualmente a versão mais comum é a versão 4)
- **Header Length** (4 bits) – tamanho do cabeçalho em blocos de 4 octetos
 - quando não tem opções, o cabeçalho ocupa 5 blocos de 4 octetos e o primeiro octeto do cabeçalho IP assume o valor 0x45
- **Service Type** (1 byte) – tipo de serviço ao qual o pacote pertence
 - Identifica o tipo de serviço e o objetivo é diferenciar o tratamento dos pacotes pelos routers com base na qualidade do serviço pretendida (por defeito, este campo tem o valor 0x00)
- **Total Length** (2 bytes) – tamanho do datagrama IP em octetos, incluindo o cabeçalho.
 - o tamanho máximo do datagrama IP é 65 535 octetos
 - no entanto este tamanho está restringido pelo *Maximum Transmission Unit* (MTU) da rede (mecanismo de fragmentação e reagrupamento)

IP version 4 header description

Version (4 bits) – version of the IP protocol (currently, version 4 is the most used version)

Header Length (4 bits) – size of IP header in multiple of 4 bytes (for example, if the header size is 20 bytes, the content of this field is 0x5).

Service Type (1 byte) – type of service of the IP datagram (used in quality of service architectures); the default value is 0x00

Total Length (2 bytes) – size of the IP datagram (header + data); the maximum size of an IP datagram is 65535 bytes; nevertheless, the physical networks have much lower MTU values; a fragmentation and reassembly mechanism is included in IP protocol to solve this issue.

MTU (Maximum Transmission Unit) of a physical network – the maximum size of the data field of its MAC layer frames (for example, the MTU of Ethernet is 1500 bytes).

Campos do Datagrama IPv4 (continuação)

- **Identification** (2 bytes) – identificador atribuído pela estação que gerou o datagrama
 - este campo é mantido durante o processo de fragmentação permitindo o destinatário identificar os vários fragmentos de um mesmo pacote
- **Flags** (3 bits)
 - o primeiro bit está reservado para uso futuro (assume sempre o valor 0)
 - o segundo bit assume o valor 0 se o datagrama puder ser fragmentado e o valor 1 caso contrário
 - o terceiro bit assume o valor 0 se for o último fragmento e 1 se não for
- **Fragment Offset** (13 bits) – posição (em múltiplos de 8 bytes) do fragmento no datagrama original (o primeiro fragmento tem o valor 0x00)

IP version 4 header description (continuation)

Identification (2 bytes) – a value assigned by the origin host to the IP datagram; this value is different for every new IP datagram; this value is copied to all IP fragment datagrams in the fragmentation of an original IP datagram (in this way, the destination host can identify the IP fragment datagrams of each original IP datagram).

Flags (3 bits):

- first bit is reserved for future use (default value is 0)

- second bit is the “**do not fragment bit**”: it is 1 if the source does not allow the IP datagram to be fragmented and 0 otherwise (if an IP datagram requires fragmentation to be transmitted over a physical network and this bit is 1, the IP datagram is discarded)

- the third bit is the “**last fragment bit**”: it is 0 if the IP datagram is the last fragment of the original IP datagram or 1, otherwise

Fragment Offset (13 bits) – position (in multiples of 8 bytes) of this fragment on the original IP datagram; the Fragment Offset value indicates how many bytes are in all previous datagrams (first fragment has the value 0x00)

NOTE: a non fragmented IP datagram reaches the destination host with Fragment Offset = 0x00 and the “last fragment bit” = 0.

Campos do Datagrama IPv4 (continuação)

- **Time to Live** (1 byte) - o máximo tempo que o datagrama pode permanecer na rede
 - é alterado em cada router e quando atinge o valor 0 o datagrama é eliminado
 - cada router decrementa este campo em 1 unidade ou no número de segundos que demorou a processar o datagrama
- **Protocol** (1 byte) - especifica o protocolo de nível superior
 - exemplos: 1 - ICMP, 6 - TCP e 17 - UDP
- **Header Checksum** (2 bytes) - resultado da soma (em palavras de 16 bits) dos outros campos do cabeçalho
 - como o header é alterado em cada router, este valor é também recalculado
 - permite detetar erros de transmissão que alterem o cabeçalho do datagrama

IP version 4 header description (continuation)

Time to Live or TTL (1 byte) – the maximum time that the IP datagram can be in transit before reaching the destination host; each router subtracts to this value the number of seconds that it takes to process it (this value is decremented at least by 1); if the value reaches 0, the router discards the IP datagram

Protocol (1 byte) – code specifying the higher layer protocol to which the data field belongs; examples: 1 - ICMP, 6 - TCP and 17 - UDP

Header Checksum (2 bytes) – result of the sum (in 16 bit words) of the other header fields; it enables each receiver (intermediate routers and destination host) to detect transmission errors in the IP header (if a transmission error is detected, the IP datagram is discarded); since the TTL field is changed by each router, the Header Checksum is also changed on each router

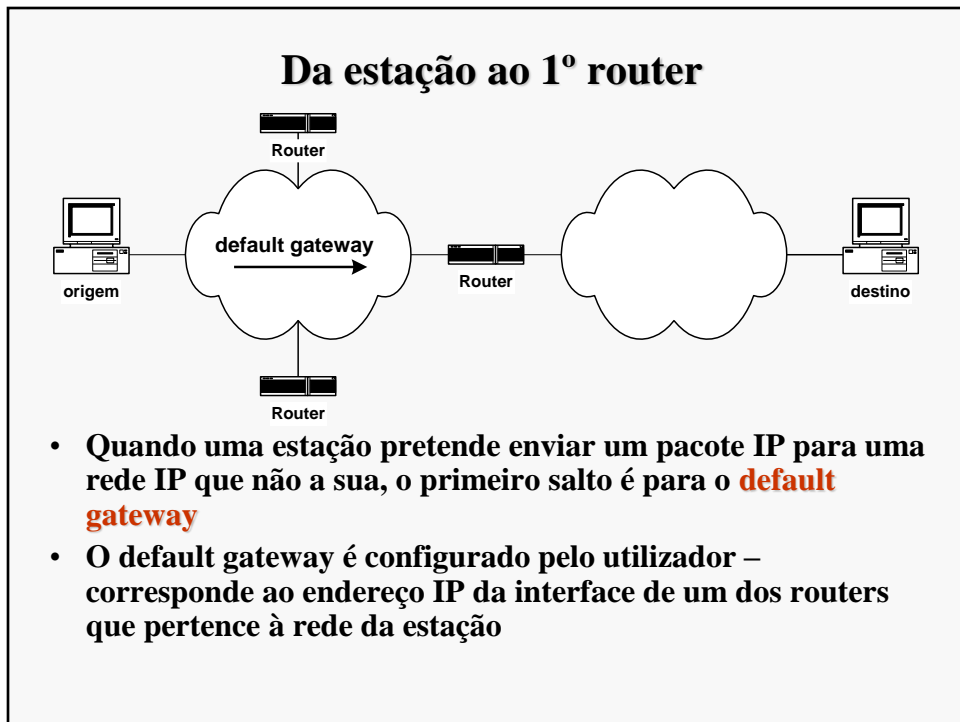

From de origin IP host to the first router

When an IP host has an IP datagram for an IP destination address, the host compares the netid part of the IP destination address with the netid part of its own IP address. If they are not equal, it means that the destination host is not attached to its physical network. In this case, the host sends the packet to the Default Gateway. In order to have global connectivity, an IP host must be configured with the IP address of its Default Gateway. This address must be an IP address assigned to a network interface of a router connected to its own physical network.

Configuração do endereço IP



The image shows a Windows network settings window titled "Edit network IP settings". At the top, there is a dropdown menu set to "Manual". Below this, the "IPv4" section is active, indicated by a blue toggle switch labeled "On". The configuration fields are as follows:

- IP address:** 192.1.1.10
- Subnet mask:** 255.255.255.0
- Gateway:** 192.1.1.254
- Preferred DNS:** 192.1.1.254
- DNS over HTTPS:** Off

IP host configuration

The figure above shows an example of an IP host configuration window (in Windows OS) where the basic information is requested: the host IP address, the netmask and the IP address of its Default Gateway.

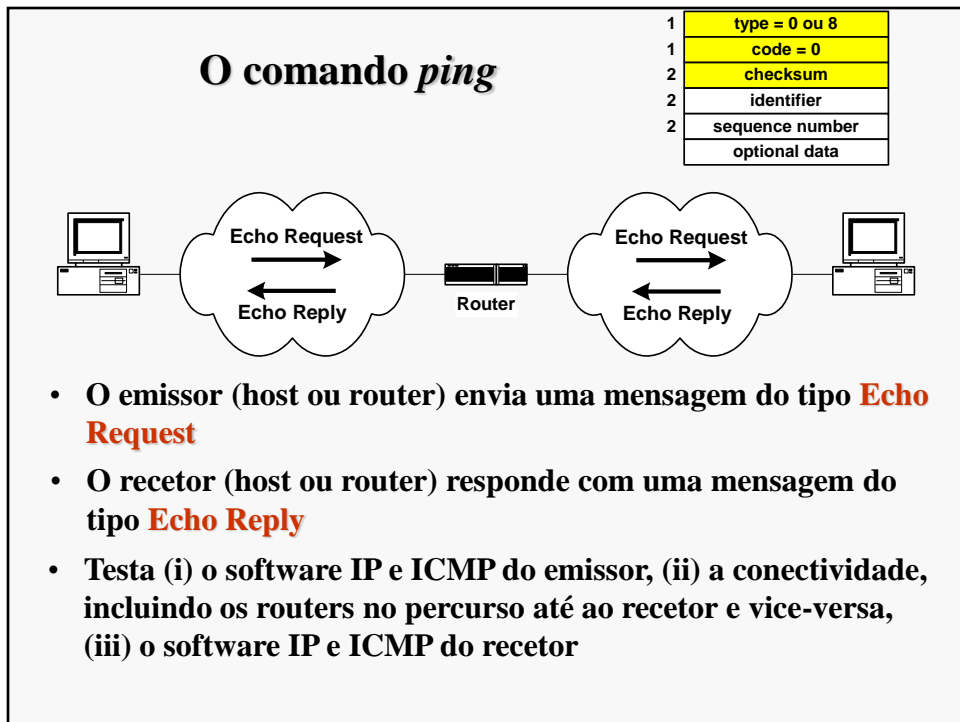

***ping* command**

The *ping* command uses the ICMP Echo Request and ICMP Echo Reply messages. When a ping command is run on an origin host to a remote IP address, some ICMP Echo Request messages are sent by the origin host for the remote IP address. When a remote host receives an ICMP Request message from an origin IP address, it sends back an ICMP Echo Reply message.

The type field is either 8 (ICMP Echo Request) or 0 (ICMP Echo Reply) and the code field is always zero. Both messages have two additional fields: the **identifier** field (2 bytes) and the **sequence number** field (2 bytes). The content of these two fields on the ICMP Echo Request messages are copied to the ICMP Echo Reply messages sent back to the origin host.

At the end of the message, optional data can be inserted to generate ICMP messages of different sizes (for example, to test fragmentation and reassembly malfunctioning). The ICMP Echo Reply messages are defined with the same optional data size as the one of the received ICMP Echo Request messages.

A successful run of ping command is when an Echo Reply is received for each sent Echo Request message. This command tests the correct operation of the TCP/IP protocol stack on the origin host, the network connectivity between origin and destination hosts and the TCP/IP protocol stack on the destination host.

LANs – Redes de área local

- **Permitem a comunicação direta entre estações próximas através de ligações partilhadas**
- **Tecnologias**
 - IEEE 802.3 Ethernet, IEEE 802.11 WiFi, IEEE 802.5 Token Ring, ...

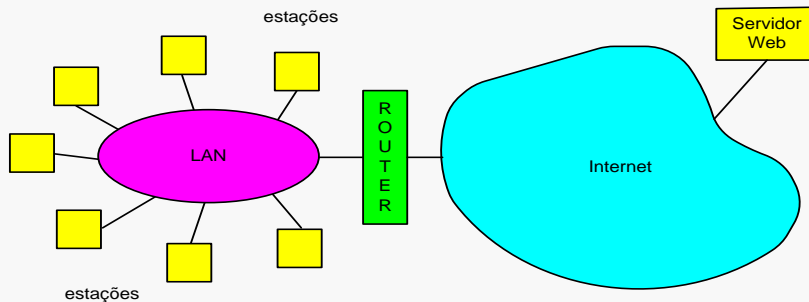

LANs – Local Area Network

Local Area Networks (LANs) are telecommunication systems enabling direct communications between terminal stations through a shared transmission medium.

Examples of LANs are the technologies standardized by IEEE like: Ethernet (IEEE 802.3), WiFi (IEEE 802.11), Token Ring (IEEE 802.5), ...

In the above picture, a LAN network provides the means for all stations to communicate directly between them and the router is the network element used by the local stations to communicate with stations on other networks.

Endereçamento LANs

- Cada adaptador (NIC) de um nó (estação, router) tem um endereço único
- Várias designações
 - Endereços MAC, físicos, de hardware, Ethernet, ...
 - Não é o mesmo que o endereço IP!
- Endereços IEEE
 - 48 bits
 - Administrados globalmente pelo IEEE
- Tipos de endereços:
 - Unicast
 - Multicast
 - Broadcast

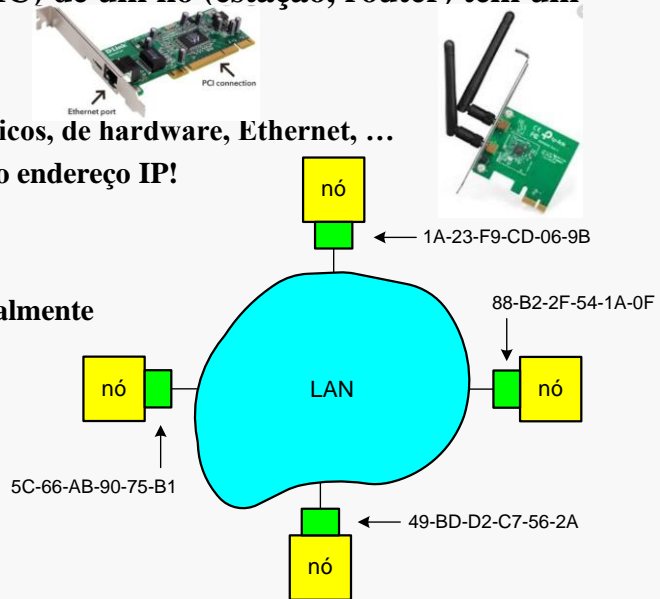

Addressing in LANs

LANs are implemented on hardware. A Network Interface Card (NIC) is a hardware device that is plugged to a terminal station, or a router, and that implements all means to communicate with the other stations on the same LAN.

Each NIC has an address. This address is referred to by multiple names: hardware address, MAC address, physical address, etc...

All IEEE technologies have the same addressing scheme: they are 48 bit long and are globally administrated by IEEE. These addresses are coded by manufacturers on NICs and are guaranteed to be unique. Unlike IP addresses, physical addresses are represented in hexadecimal notation.

There are three types of addresses: unicast addresses (an unicast address identifies a NIC), multicast addresses (used for multicast communications) and the broadcast address (a special address used as destination address when an origin station wants to send a frame to all other terminal stations attached to the same LAN).

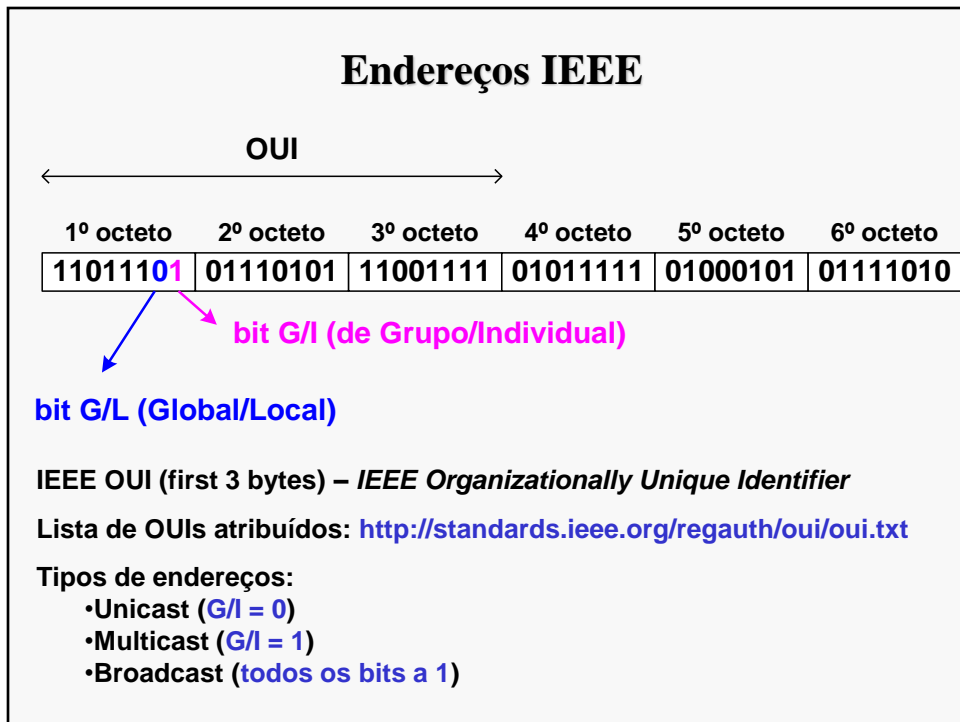

IEEE Addresses

IEEE is the global authority responsible for assigning blocks of IEEE addresses to NIC manufacturers. The 3 first bytes are used for this assignment and are named the IEEE Organizationally Unique Identifier (OUI). When a block is assigned to a manufacturer, it uses the 3 last bytes to assign different addresses to different NICs. Note that a manufacturer can be assigned more than one block, depending on its needs.

The last two bits of the first byte have special meanings:

- The 7th bit is 0 if it is a globally assigned address or 1 if it is a locally administered address (IEEE assigned blocks have always this bit set to 0).
- The 8th bit is 0 if it is a unicast address or 1 if it is a multicast address (IEEE assigned blocks have always this bit set to 0).

The special broadcast address is defined by all bits equal to 1: the address FF-FF-FF-FF-FF-FF.

The list of IEEE assigned blocks is public (<http://standards.ieee.org/regauth/oui/oui.txt> , for example).

Encapsulamento de datagramas IP

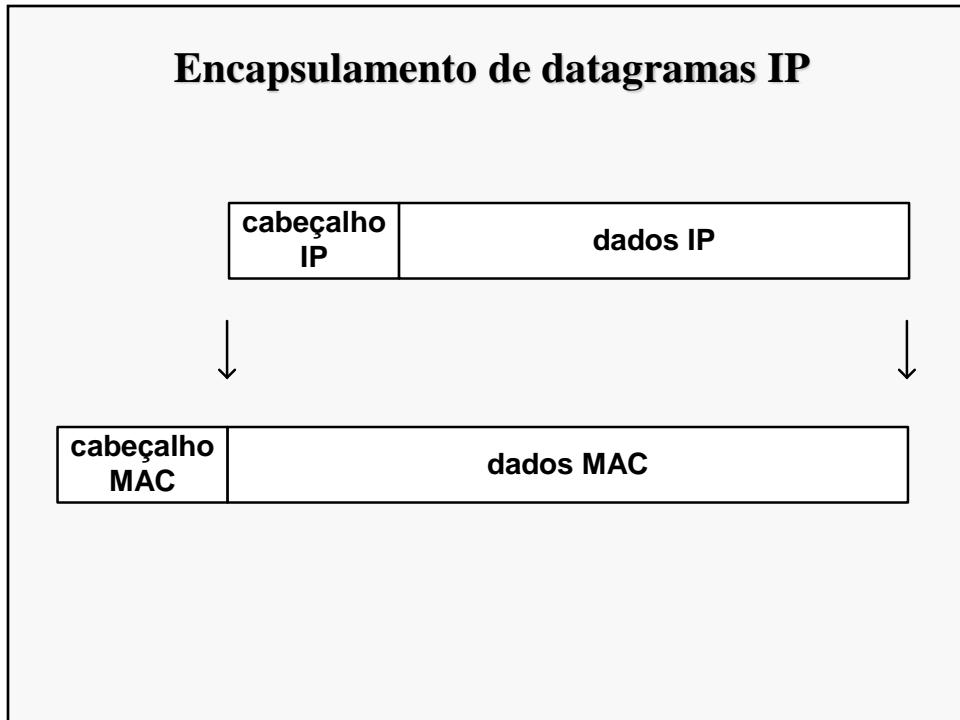

Encapsulation of IP datagrams

IP protocol sends information in the form of datagrams. For each block of bytes delivered by the above protocol, IP protocol adds an header forming in this way an IP datagram. Each IP datagram (composed by an IP header field and a data field) is delivered to the lower MAC layer to be sent to the network.

At each physical network, a MAC layer frame is composed by a MAC header field and a data field. At each physical network, each IP datagram is transmitted in the data field of a MAC layer frame (process known as encapsulation).

MAC (Medium Access Control) – is the protocol running on the physical network that manages the way how the transmission medium is used by each attached host to send MAC layer frames to other hosts.

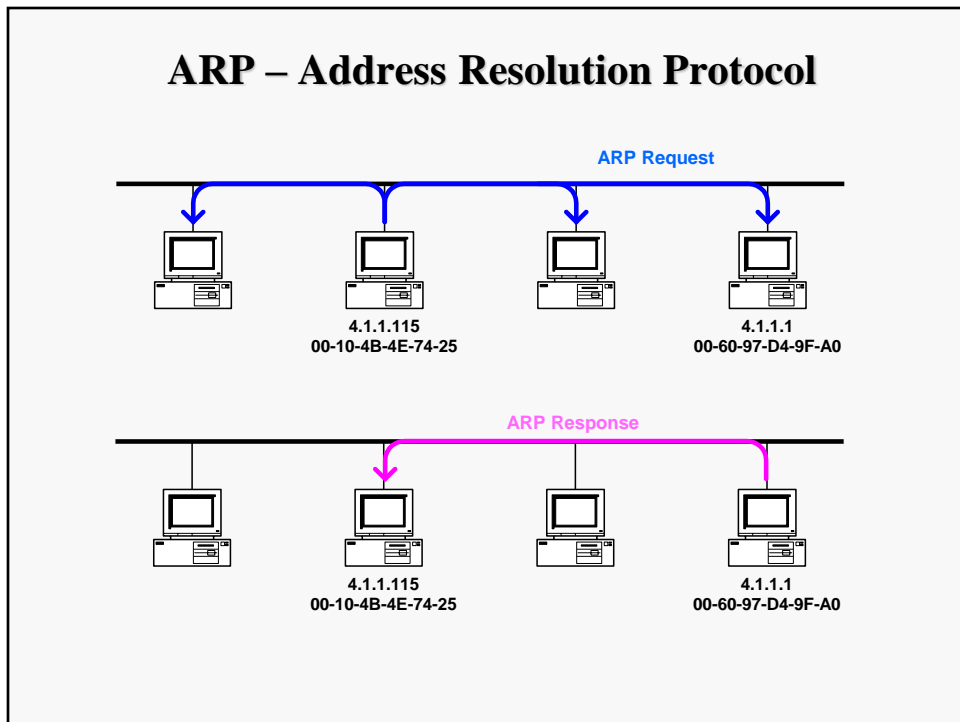

ARP – Address Resolution Protocol

Each physical network technology has its own addresses. The technologies standardized by IEEE (for example, Ethernet, Token Ring, WiFi or WiMax), use the same addressing scheme: each address has a size of 6 bytes. These addresses are coded by manufacturers on NICs (Network Interface Cards) and are guaranteed to be unique (unlike IP addresses, physical addresses are represented in hexadecimal notation).

In the figure above, if the host 4.1.1.115 has an IP datagram to send to host 4.1.1.1, the IP datagram must be encapsulated on a MAC layer frame where the frame header must specify the origin and destination MAC addresses. Before doing that, host 4.1.1.115 must first know what is the MAC address of the host whose IP address is 4.1.1.1.

This is done through the Address Resolution Protocol (ARP). First, host 4.1.1.115 sends an ARP Request packet to all hosts requesting the MAC address of the host whose IP address is 4.1.1.1. If such an host is active, it sends an ARP reply packet, only to the requesting host, with the requested information.

ARP Request

No.	St.	Source Address	Dest Address	Layer	Summary	Len
1	Ok	This station	Broadcast	ARP	Op=ARP Request	46
2	Ok	006097D49FA0	This station	ARP	Op=ARP Response	64
3	Ok	This station	Broadcast	ARP	Op=ARP Request	46

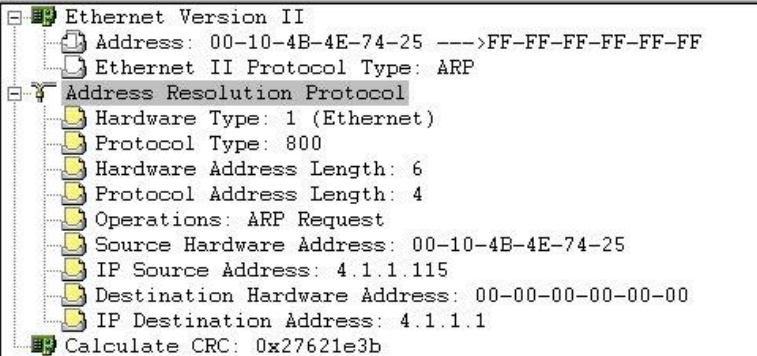

The screenshot shows a network analysis tool interface. It displays a tree view of network layers. The top level is 'Ethernet Version II', which is expanded to show 'Address: 00-10-4B-4E-74-25 --->FF-FF-FF-FF-FF-FF' and 'Ethernet II Protocol Type: ARP'. Below this is 'Address Resolution Protocol', which is also expanded to show details: 'Hardware Type: 1 (Ethernet)', 'Protocol Type: 800', 'Hardware Address Length: 6', 'Protocol Address Length: 4', 'Operations: ARP Request', 'Source Hardware Address: 00-10-4B-4E-74-25', 'IP Source Address: 4.1.1.115', 'Destination Hardware Address: 00-00-00-00-00-00', and 'IP Destination Address: 4.1.1.1'. At the bottom, it shows 'Calculate CRC: 0x27621e3b'.

ARP Request enviado pela estação 4.1.1.115 para saber o endereço MAC da estação 4.1.1.1.

ARP Request

ARP packets are encapsulated in MAC layer frames. The above is the content of an ARP Request packet encapsulated on an Ethernet frame. In the Ethernet frame header, the origin address is the MAC address of host 4.1.1.115 and the destination address is the MAC broadcast address FF-FF-FF-FF-FF (an address with all bits equal to 1). The ARP Request packet specifies the origin MAC and IP addresses, the destination IP address and an empty destination MAC address.

ARP Reply

No.	St.	Source Address	Dest Address	Layer	Summary	Len	Rel. Time
1	Ok	This station	Broadcast	ARP	Op=ARP Request	46	0:00:07
2	Ok	006097D49FA0	This station	ARP	Op=ARP Response	64	0:00:07
3	Ok	This station	Broadcast	ARP	Op=ARP Request	46	0:00:07

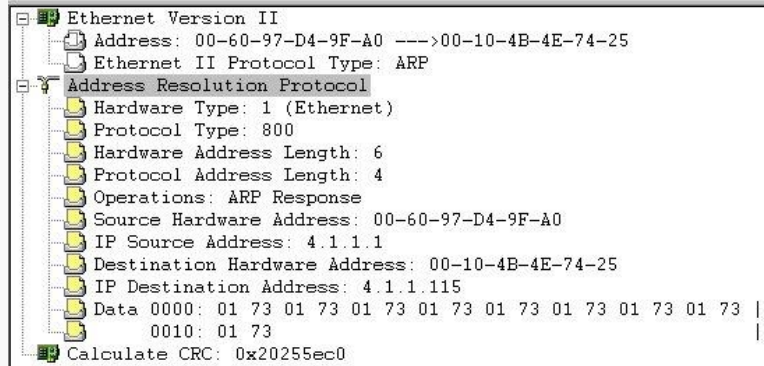

The screenshot shows a network analysis tool interface. It displays a tree view of network layers for an ARP Reply packet. The layers are: Ethernet Version II (Address: 00-60-97-D4-9F-A0 --->00-10-4B-4E-74-25), Ethernet II Protocol Type: ARP, and Address Resolution Protocol. Under ARP, it shows: Hardware Type: 1 (Ethernet), Protocol Type: 800, Hardware Address Length: 6, Protocol Address Length: 4, Operations: ARP Response, Source Hardware Address: 00-60-97-D4-9F-A0, IP Source Address: 4.1.1.1, Destination Hardware Address: 00-10-4B-4E-74-25, IP Destination Address: 4.1.1.115, and Data: 0000: 01 73 01 73 01 73 01 73 01 73 01 73 01 73 01 73 | 0010: 01 73 |. At the bottom, it shows Calculate CRC: 0x20255ec0.

**Resposta da estação 4.1.1.1 enviada através de ARP Response:
o endereço MAC é 00-60-97-d4-9f-a0**

ARP Response

The above is the content of an ARP Reply packet encapsulated on a Ethernet frame. In the Ethernet frame header, the origin address is the MAC address of host 4.1.1.1 and the destination address is the MAC address of host 4.1.1.115 (which is the requester). The ARP Reply specifies its MAC and IP addresses and the destination MAC and IP addresses.

Fragmentação e reassemblagem em IP

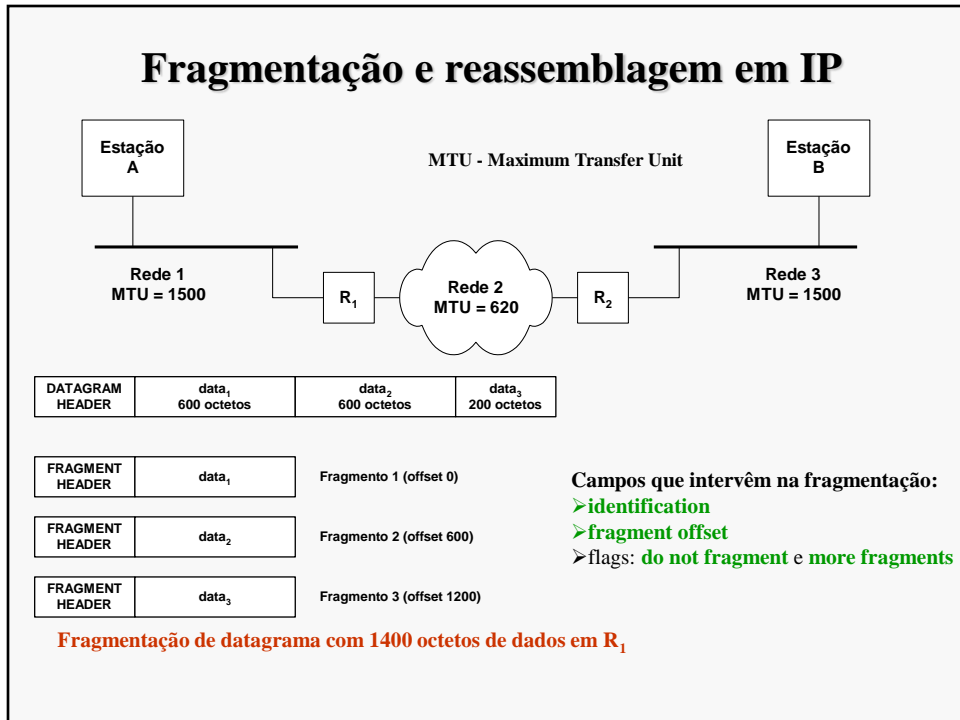

Fragmentation and reassembly process

When an IP datagram is larger than the MTU of the physical network, the sending host must fragment it in multiple smaller IP datagrams whose size is not larger than the MTU. The fragmentation operation can be done by either the origin host or any router.

IMPORTANT NOTE: All IP fragment datagrams are forwarded individually towards the destination host. The reassembly operation (i.e., the operation of joining all fragments to recover the original IP datagram) is conducted only by destination host.

The IP fragmentation process is as follows:

1. The data field is segmented in an ordered set of blocks such that each block plus the header is not larger than the MTU. Each block with its header forms an IP fragmented datagram.
2. The Identification field of all fragments is set with the Identification field of the original IP datagram (in this way, the destination host can identify all fragments of an IP datagram).
3. The Fragment Offset field of fragment n is set with the total number of data bytes send by all previous fragments from 1 to $n - 1$ (in this way, the destination host can identify missing fragments and can order the fragments if they are received out of order).
4. The 'more fragments' flag is set with 0 in the last fragment and 1 in all previous fragments (in this way, the destination host can know what is the last fragment and, therefore, check if all fragments were received).

In the above figure, router R₁ has an IP packet with 1400 bytes of data for host B. The packet is fragmented in three IP fragmented packets. Since the MTU of the forwarding network is 620 bytes, the first two fragments have data blocks of 600 bytes and the third fragment has the remaining 200 bytes. The Fragment Offset is 600 in the second fragment (the data of the first fragment) and is 1200 in the third fragment (the total data of the first and second fragments).

Exemplo

- Num ping do PC A para o PC B, o PC A envia uma mensagem ICMP de 900 bytes. Os pacotes IP que transportam esta mensagem têm o campo IDENTIFICATION com o valor 385. Indique justificadamente quantos fragmentos IP são recebidos pelo PC B, quem gera os fragmentos IP e qual o tamanho (em Bytes) de cada fragmento IP (incluindo o cabeçalho).

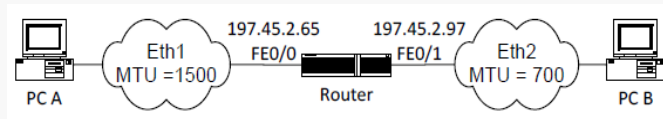

Switching

Bridges/switches versus repetidores/hubs (II)

- **Consequências (II):**

- As colisões deixam de ser um problema
- A largura de banda agregada não é limitada pela taxa de transmissão das portas

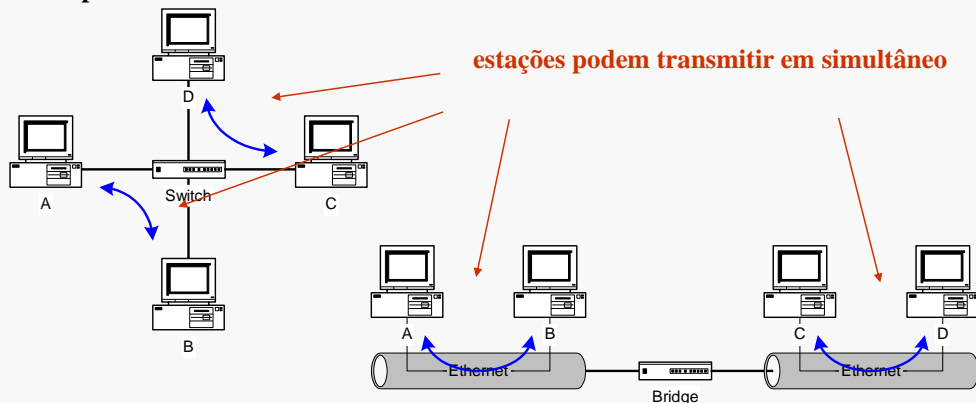

Bridges/Switches versus Repeaters/Hubs (II)

Other positive consequences are:

- Collisions are eliminated (bridges / switches can be simultaneously receiving frames and sending frames in different ports)
- The total transmission rate of the equipment is not constrained to the transmission rate of a single port but, instead, it is given by the sum of the transmission rates of all ports

In a 10BaseT network, when an hub is replaced by a switch (left picture above), all attached terminal stations can be simultaneously transmitting and receiving frames (no CSMA/CD is required and the interfaces can operate in full duplex mode).

In a 10Base2 (or 10Base5) network, when a repeater is replaced by a bridge (right picture above), simultaneous frames can be transmitted on the different attached segments. Note, however, that in this case CSMA/CD is still required on each segment (why?).

Tabela de Encaminhamento do Switch

- **Pergunta:** como é que o switch sabe que A' é atingido via 4, por exemplo?
- **Resposta:** cada switch tem uma tabela de encaminhamento, em que cada entrada é da forma:
 - (endereço MAC, interface, tempo de vida)
- **Pergunta:** como é que estas entradas são criadas e mantidas?

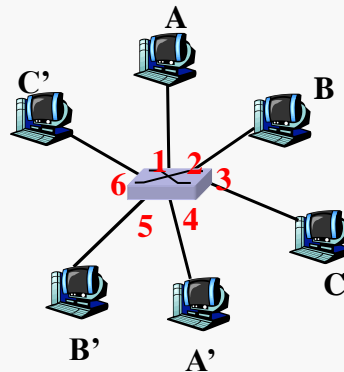

switch com 6 interfaces
(1,2,3,4,5,6)

MAC Address Table of a Switch

How can switches perform the filtering function, i.e., how do switches know “where” is the destination station of each incoming frame? First, switches assign a port ID value to each of its ports. In the above picture, if the switch receives a frame destined to host A', how does it know that the frame must be forward through port 4?

To perform this task, switches have a routing table (commonly named MAC Address Table) where each entry has: (i) a MAC address, (ii) a port number (iii) and a time-to-live (TTL) value.

How is the MAC Address Table managed? See next slide.

Switch: auto-aprendizagem

- O switch *aprende* que estações podem ser atingidas por cada uma das suas interfaces
 - quando uma trama é recebida numa interface, o switch regista na tabela de encaminhamento uma entrada com o endereço MAC origem da trama e a interface de entrada

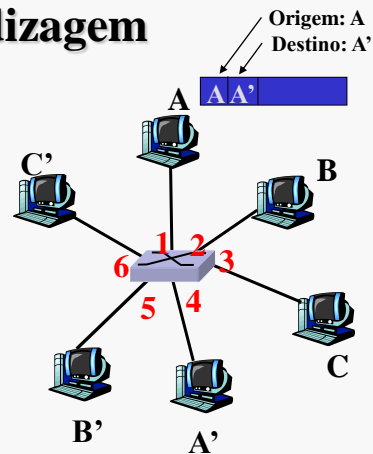

MAC addr	interface	TTL
A	1	60

Tabela do switch
(inicialmente vazia)

Switch: self-learning process

Switches learn which terminal stations can be reached through which ports: when a frame is received on an incoming port, the switch includes in the MAC Address Table an entry with the MAC origin address of the frame, the incoming port and a pre-defined TTL value.

In the above example, host A sends a frame with the origin MAC address of A and destination MAC address of A'. Upon reception of this frame on port 1, an entry is inserted in the MAC Address Table associating MAC address of A with port 1.

Exemplo

- Destino da trama A' desconhecido:
flooding
- Destino da trama A conhecido:
forwarding

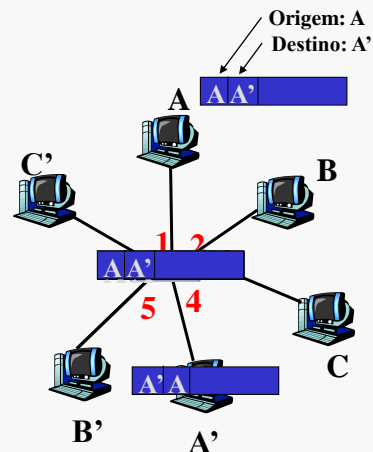

MAC addr	interface	TTL
A	1	60
A'	4	60

Tabela do switch
(inicialmente vazia)

Example

Consider the above example where at the beginning the MAC Address Table is empty.

- First, station A sends a frame with the origin MAC address of A and destination MAC address of A'.
- Upon reception of this frame on port 1, an entry is inserted in the MAC Address Table associating MAC address of A with port 1.
- This frame is flooded to ports 2, 3, 4, 5 and 6 because the MAC Address Table does not have any entry with the MAC address of A'.
- Then, station A' sends a frame with the origin MAC address of A' and destination MAC address of A.
- Upon reception of this frame on port 4, an entry is inserted in the MAC Address Table associating MAC address of A' with port 4.
- This frame is forwarded to port 1 because the MAC Address Table has an entry specifying that the MAC address of A is reachable through port 1.

Aprendizagem de endereços

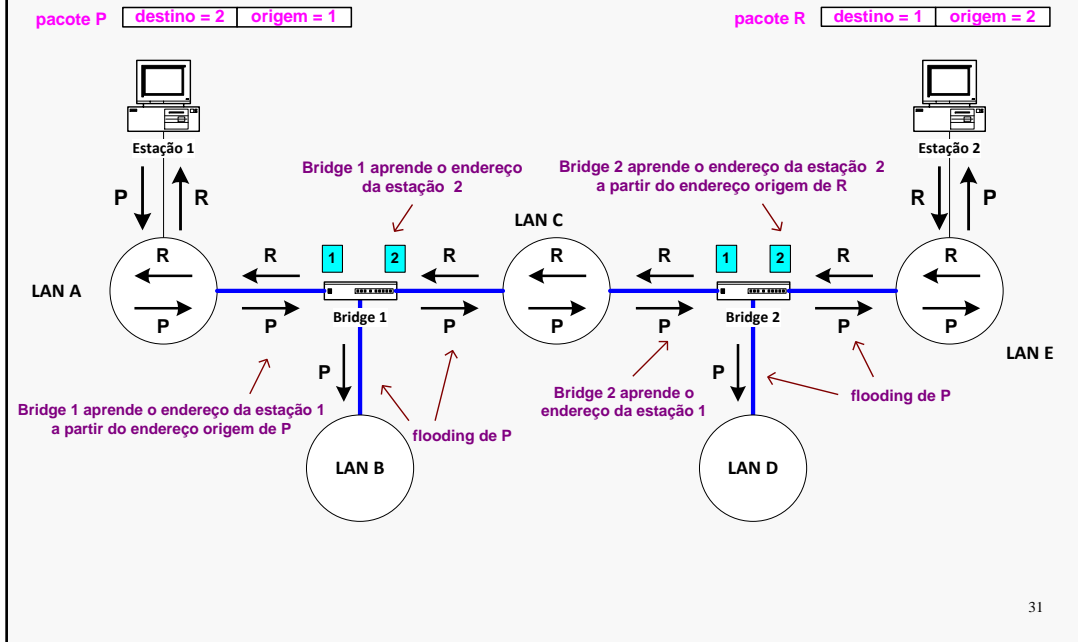

MAC Address Learning Process

What happens when a network is composed by multiple switches / bridges? The self-learning and forwarding processes work exactly the same as in the single element case.

The above picture illustrates these processes resorting to a network of bridges (the same thing happens with a network of switches):

- First, station 1 sends a frame to station 2
- Bridge 1 learns that station 1 is reachable through its port connected to LAN A and floods the frame to LAN B and LAN C.
- Bridge 2 learns that station 1 is reachable through its port connected to LAN C and floods the frame to LAN D and LAN E.
- Then, Station 2 sends a frame to station 1
- Bridge 2 learns that station 2 is reachable through its port connected to LAN E and forwards the frame to LAN C.
- Bridge 1 learns that station 2 is reachable through its port connected to LAN C and forwards the frame to LAN A.

Tempo de vida das entradas das tabelas de encaminhamento

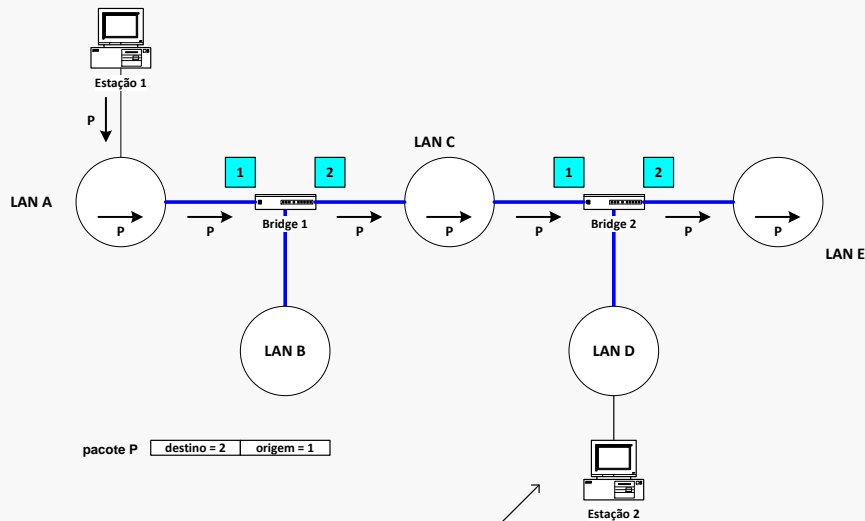

Estação 2 muda de LAN: não recebe pacotes

- até transmitir ou até
- expirar tempo de vida da sua entrada na tabela de encaminhamento

32

TTL of MAC Address Table Entries

Remember that each entry of the MAC Address Table has an associated time-to-live (TTL) value. This value is set to a pre-defined value every time that the switch receives a frame from the origin terminal station. Then, the entry is deleted if no frames are received from the origin station during TTL seconds (we say that the time of the entry has expired).

Consider the example of the previous slide where, meanwhile, station 2 changes its point of attachment from LAN E to LAN D (above figure). In this case, the MAC Address Table of bridge 2 becomes wrong and frames sent by station 1 to station 2 will not reach their destination (causing lost of connectivity).

If, meanwhile, station 2 sends a frame to the network, it will enable bridge 2 to update its MAC Address Table associating the MAC address of station 2 to the new port and connectivity is recovered.

Otherwise, the connectivity will be recovered when the entry of the bridge 2 in the MAC Address Table expires, which will cause the flooding of frames to station 2.

Encaminhamento em bridges

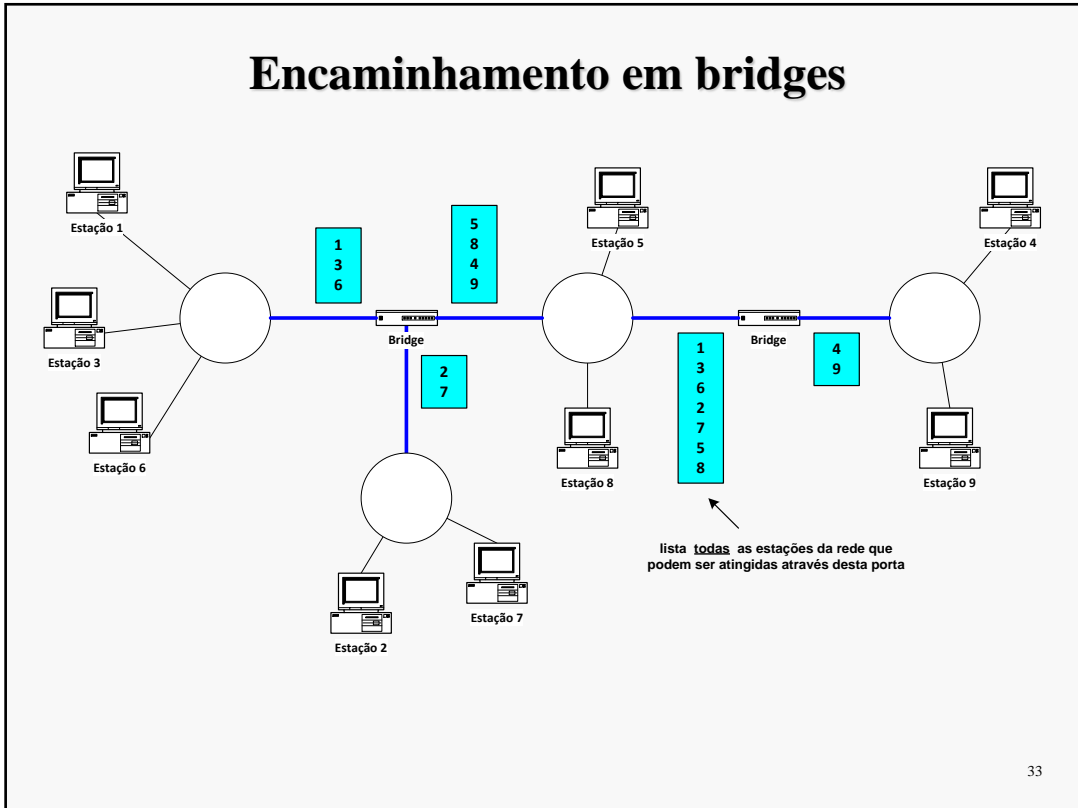

Routing on Bridges/Switches

Bridges / switches use data frames to learn which terminal stations can be reached by each of its own ports.

Exercício

- Considere a seguinte tabela de encaminhamento de um Switch com 8 portas:

00:01:42:b5:45:f1 – port 4

00:0e:0c:3e:45:c3 - port 1

00:11:52:a5:45:f2 - port 4

00:1F:02:1e:34:B1 - port 2

Das afirmações que se seguem, assinale as afirmações verdadeiras e as falsas:

- a) Se na porta 1 do Switch chegar uma trama Ethernet com endereço MAC de destino 00:00:00:00:AA:AA esta será reenviada por todas as portas do Switch
- b) Se na porta 5 do Switch chegar uma trama Ethernet com endereço MAC de destino 00:00:00:00:AA:AA será adicionada à tabela de encaminhamento a entrada “00:00:00:00:AA:AA port 5”
- c) Se na porta 4 do Switch chegar uma trama Ethernet com endereço MAC de origem 00:00:00:00:AA:AA será adicionada à tabela de encaminhamento a entrada “00:00:00:00:AA:AA port 4”
- d) Se na porta 8 do Switch chegar uma trama Ethernet com endereço MAC de origem 00:1F:02:1e:34:B1, a 4ª entrada da tabela será substituída por “00:1F:02:1e:34:B1 port 8”
- e) Se na porta 1 do Switch chegar uma trama Ethernet com endereço MAC de destino 00:11:52:a5:45:f2 esta será reenviada apenas pela porta 4 do switch

Routing

Encaminhamento IP (I)

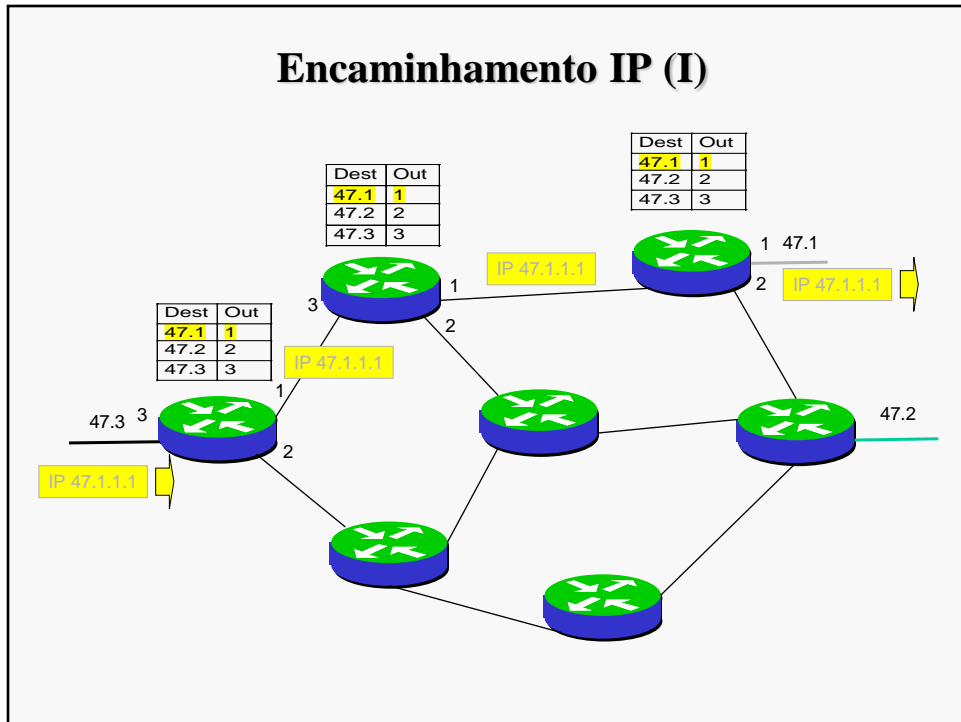

IP routing (I)

Routers are the network elements responsible to forward each IP datagram towards its destination host. In order to reach this task, each router has a routing table which defines the output port to be used towards each possible destination.

In the figure above, this task is illustrated in a very simplified way. The first router receives on port 3 an IP datagram from the origin host to the IP destination host 47.1.1.1. The router checks its routing table and finds an entry stating that datagrams for IP addresses starting by 47.1 should be transmitted through output port 1 and, therefore, it forwards this datagram through this port. The process is repeated on the second and the third routers.

Encaminhamento IP (II)

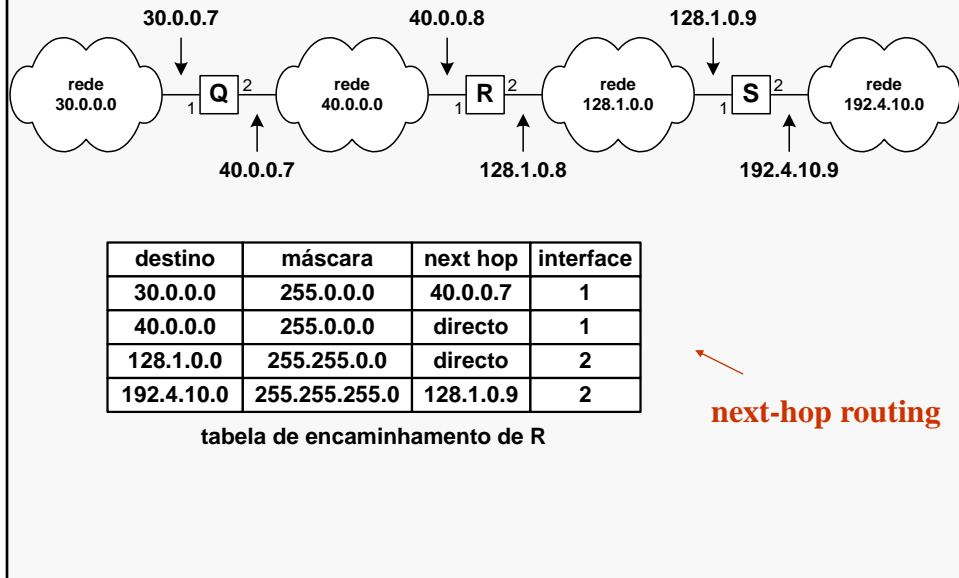

IP routing (II)

In the above example, some more details on routing tables are shown. It shows the routing table of router R in the network shown. Each routing table entry identifies:

- a destination network (specified by its IP network address and netmask),
- the output port to forward the datagrams towards the destination network,
- the IP address of the next router network interface in the path towards the destination network.

Routing on IP networks is sometimes also referred to as “next-hop routing” since each router forwards each datagram based on the identification of the next hop router in the path towards the destination.

Note that if the destination network is directly attached to the router, the IP address of the next hop router is absent (in the routing table) since, in this case, the router must send the datagram directly to the destination host.

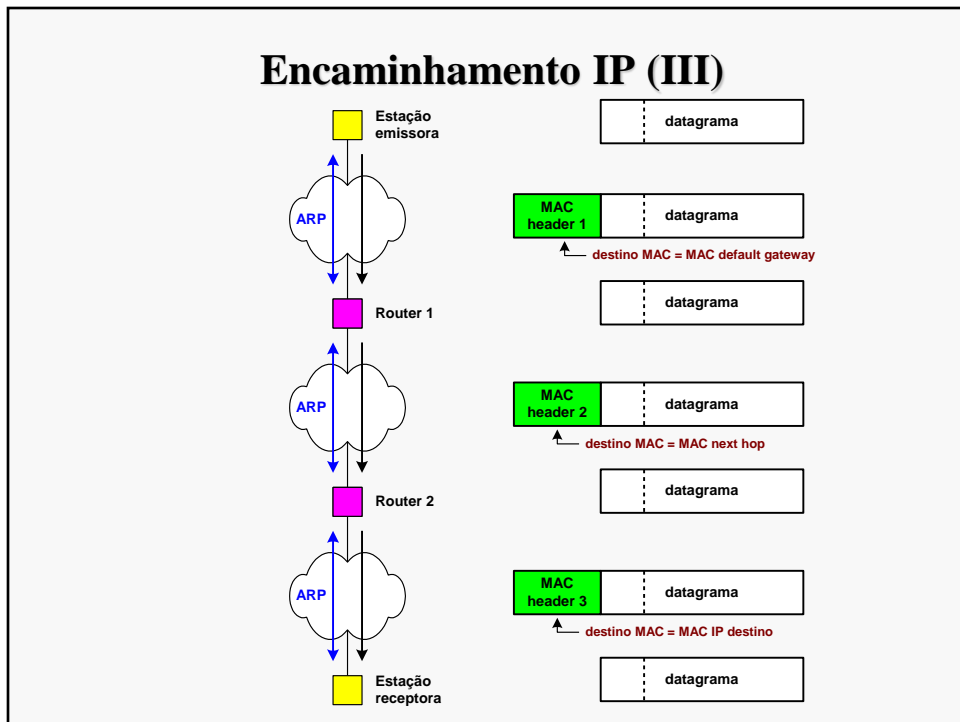

IP routing (III)

In general, the transmission of an IP datagram from an origin host to a destination host involves the following steps:

1. If necessary, the origin host discovers (through ARP) the MAC address of its Default Gateway.
2. The IP datagram is encapsulated on a MAC layer frame (with its MAC address as source address and the MAC address of the Default Gateway as destination address) and is sent to the network.
3. On each router before the last in the path towards the destination host:
 - 3.1. The router decapsulates the IP datagram from the incoming MAC layer frame.
 - 3.2. From its routing table, gets the outgoing port to be used and the next hop IP address for the destination network.
 - 3.3. If necessary, discovers (through ARP) the MAC address of the next hop IP address.
 - 3.4. The IP datagram is encapsulated on a MAC layer frame (with the MAC address of the outgoing port as source address and the MAC address of the next hop router as destination address) and is sent through the outgoing port.
4. On the last router in the path towards the destination host:
 - 4.1. The router decapsulates the IP datagram from the incoming MAC layer frame.
 - 4.2. From its routing table, gets the outgoing port to be used and the information that the destination host is in the directly attached network.
 - 4.3. If necessary, discovers (through ARP) the MAC address of the destination IP address.
 - 4.4. The IP datagram is encapsulated on a MAC layer frame (with the MAC address of the outgoing port as source address and the MAC address of the destination host as destination address) and is sent through the outgoing port.

Encaminhamento IP (IV)

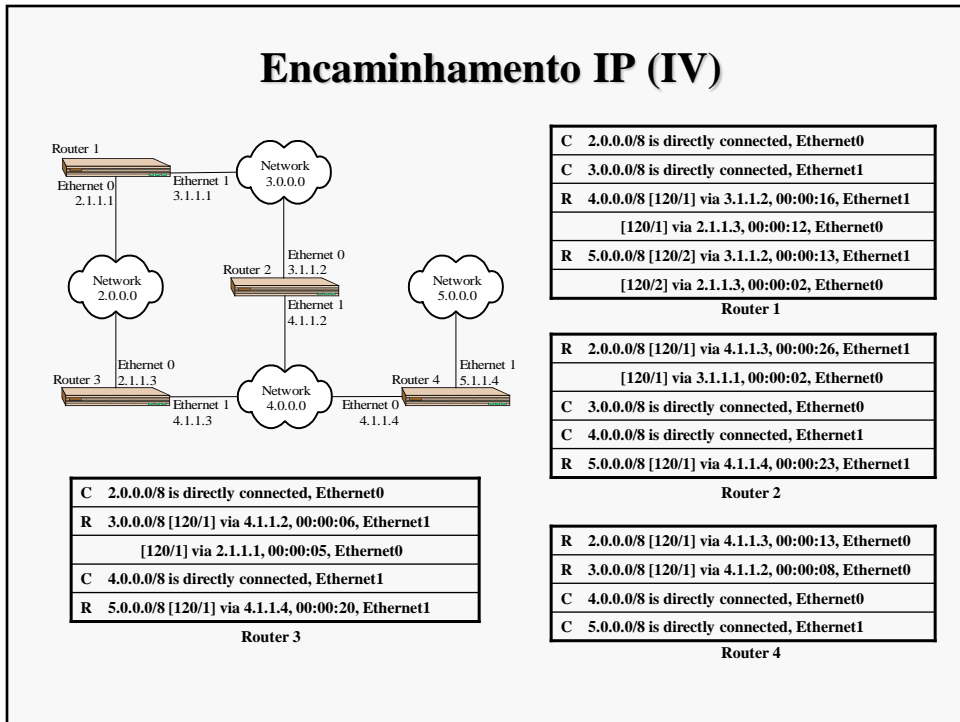

IP routing (IV)

For the network shown above, composed by four routers interconnecting four Ethernet networks, the routing tables observed in the routers are presented. In this case, the RIP routing protocol is active on all routers to compute the routing tables. This routing protocol composes the routing tables with the next hop routers that provide the minimum number of hops towards the destination network (entries starting with the letter 'R').

Note that a router might have more than one entry for each destination (if there are multiple routing paths with the same minimum number of hops). When this happens, routers implement load balancing: they use all entries in a way to equally balance the use of all routing paths.

ICMP – Internet Control Message Protocol

- Permite a troca de mensagens de controle e diagnóstico
- Os pacotes ICMP são encapsulados nos pacotes IP
- O campo *Checksum* é determinado com base em toda a mensagem (detecção de erros de transmissão em toda a mensagem)

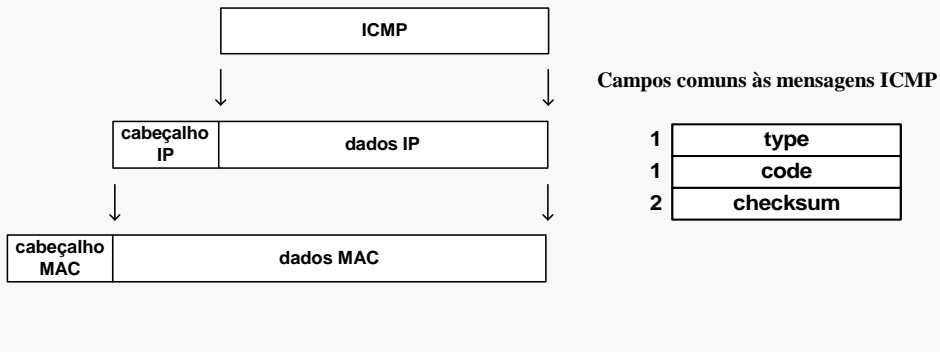

Internet Control Message Protocol (ICMP)

Internet Control Message Protocol (ICMP) is part of the Internet Protocol Suite. ICMP messages are generated either in response to errors in IP datagrams or for diagnostic or routing purposes. In the case of response to errors, ICMP messages are always sent to the IP address of the origin host of the IP datagram.

ICMP messages are encapsulated on IP datagrams. The three first fields of an ICMP message are common to all ICMP messages: **type** (1 byte), **code** (1 byte) and **checksum** (2 bytes).

The checksum field is computed based on the content of the complete message and enables the destination host to check for transmission errors on the complete message.

Tipos de mensajes ICMP

Campo type	Significado
0	Echo Reply
3	Destination unreachable
4	Source quench
5	Redirect
8	Echo request
11	Time exceeded
12	Parameter problem
13	Timestamp request
14	Timestamp reply

ICMP message types

The type field (the first field of an ICMP message) defines the type of ICMP message. In the above, some ICMP message types are identified together with their assigned type values. In the following slides, some of these message types are further addressed.

ICMP Destination Unreachable

The diagram shows a host with IP 192.168.8.224 connected to a router with IP 192.168.8.254. The router is labeled as the Default Gateway. A network capture window shows the following ICMP Echo Request messages:

No.	Status	Source Address	Dest Address	Layer	Summary	Len	Prot
1	Ok	192.168.8.224	10.0.0.1	ICMP	Type=Echo Request, ID=256, Seq No=8448	78	C
2	Ok	192.168.8.254	192.168.8.224	ICMP	Type=Destination Unreachable, Code=Host Unreach	74	C
3	Ok	192.168.8.224	10.0.0.1	ICMP	Type=Echo Request, ID=256, Seq No=8704	78	C
4	Ok	192.168.8.254	192.168.8.224	ICMP	Type=Destination Unreachable, Code=Host Unreach	74	C
5	Ok	192.168.8.224	10.0.0.1	ICMP	Type=Echo Request, ID=256, Seq No=8960	78	C
6	Ok	192.168.8.254	192.168.8.224	ICMP	Type=Destination Unreachable, Code=Host Unreach	74	C
7	Ok	192.168.8.224	10.0.0.1	ICMP	Type=Echo Request, ID=256, Seq No=9216	78	C

The capture also shows a detailed view of the ICMP Destination Unreachable message (packet 2):

- Fragment ID: 42
- Flags: May be fragmented, Last fragment, Offset=0 (0x00)
- Time to live: 255 seconds/hops
- IP protocol type: ICMP (0x01)
- Checksum: 0x2B6C
- IP address 192.168.8.254 -> 192.168.8.224
- No option
- Internet Control Message Protocol
- Type: 3 - Destination Unreachable
- Code: 1 - Host Unreachable
- Checksum: 0xA7A2
- Unused (MBZ): 0x0000-0000
- Internet Header + 64 bits of datagram: (28 bytes)
- Version (MSB 4 bits): 4
- Header length (LSB 4 bits): 5 (32-bit word)
- Service type: Preced-Routine, Delay-Normal, Thruput-Normal, Reli-Normal
- Total length: 60 (Octets)
- Fragment ID: 6916
- Flags: May be fragmented, Last fragment, Offset=0 (0x00)
- Time to live: 31 seconds/hops
- IP protocol type: ICMP (0x01)
- Checksum: 0xA034
- IP address 192.168.8.224 -> 10.0.0.1
- No option
- 64 bits of Datagram: (8 bytes)
- Sliced Packet (Data Length = 70)

Pacotes capturados na rede 192.168.8.0

ICMP Destination Unreachable message

The ICMP Destination Unreachable message (type field is 3) is used when the destination of an IP datagram cannot be reached.

There are 6 possible values for the code field:

Code 0 - Net Unreachable - sent by a router if it does not know a route to the requested network.

Code 1 - Host Unreachable - sent by a router if it knows a route to the requested network but cannot reach the destination host.

Code 2 - Protocol Unreachable – sent by the destination host if the destination protocol is not running.

Code 3 - Port Unreachable – sent by the destination host if no application is active on the destination port number.

Code 4 - Cannot Fragment - sent by a router if it needs to fragment an IP datagram but the 'do not fragment' bit is 1 in the IP header.

Code 5 - Source Route Failed - IP Source Routing is one of the IP Header Options.

In the above example, when running the ping command in the host for the IP address 192.168.8.254, the ICMP Echo Request messages reach the router that does not know how to reach the destination host. The ICMP Echo Requests are discarded and the Router sends to the origin host an ICMP Destination Unreachable message with code Host Unreachable. The outcome of the ping command indicates the IP address of the router reporting the situation.

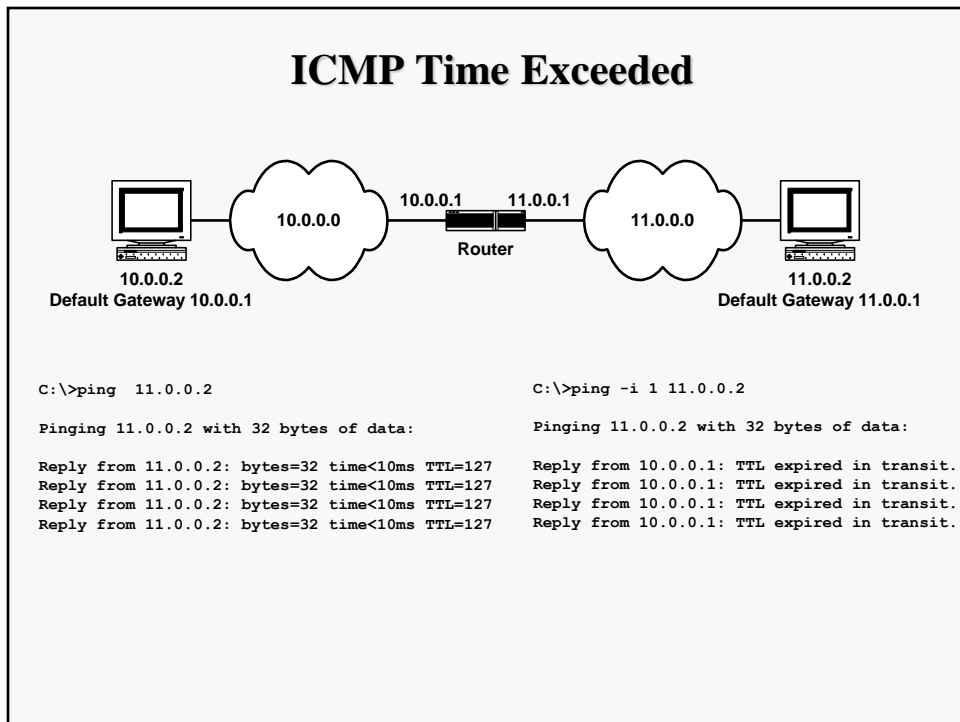

ICMP Time Exceeded message

The ICMP Time Exceeded message (type field is 11) is sent by a router to the origin host of an incoming IP datagram when it is discarded due to the fact that its TTL value reaches zero.

In the above example, if the ping is set with an origin TTL equal to 1, the first router discards the message and replies with an ICMP Time Exceeded message (indicated in the output of the ping command).

Comando *tracert*

- Permite descobrir o percurso utilizado no encaminhamento dos pacotes
- Recorre ao campo TTL e a mensagens ICMP Time Exceeded

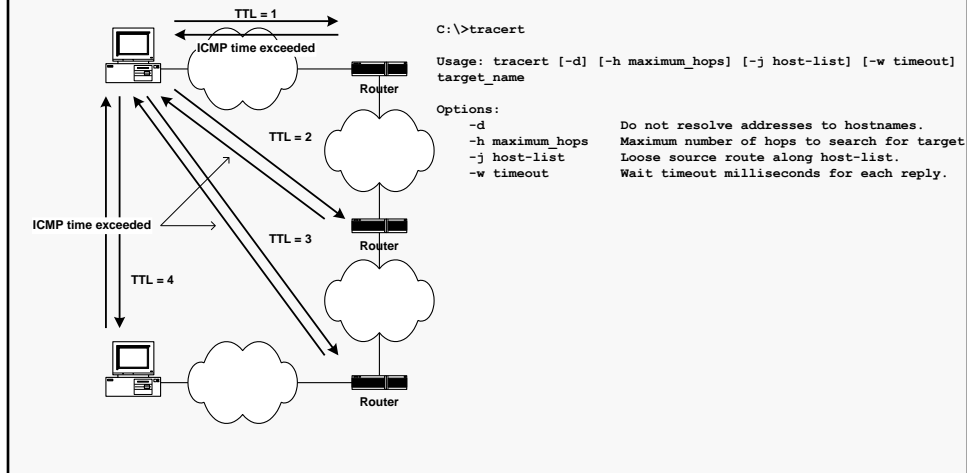

tracert command

tracert command is a diagnosis tool for displaying routing paths and measuring transit delays of IP datagrams across the IP network.

When running the *tracert* command on an origin host to a destination IP address, the origin host starts sending 3 ICMP Echo Request messages with TTL = 1. For each of these messages, the first router replies with one ICMP Time Exceeded message (the three messages give three measures of the round-trip-time to the first router). Then, the origin host repeats the process with growing values of TTL until it receives ICMP Echo Replies from the destination host. For each value of TTL, a new router of the routing path is discovered and three measures of the round-trip-time are obtained for that router.

Exemplo – *tracert*

```
C:\>tracert -d 193.136.173.30
```

```
Tracing route to 193.136.173.30 over a maximum of 30 hops
```

```
  1  <10 ms  <10 ms  <10 ms  193.136.92.1
  2  <10 ms  <10 ms  <10 ms  193.137.172.254
  3  <10 ms  <10 ms  <10 ms  193.136.173.30
```

```
Trace complete.
```

No.	Source Address	Dest Address	Summary
1	[193.136.92.243]	[193.136.173.30]	ICMP: Echo
2	[193.136.92.1]	[193.136.92.243]	ICMP: Time exceeded
3	[193.136.92.243]	[193.136.173.30]	ICMP: Echo
4	[193.136.92.1]	[193.136.92.243]	ICMP: Time exceeded
5	[193.136.92.243]	[193.136.173.30]	ICMP: Echo
6	[193.136.92.1]	[193.136.92.243]	ICMP: Time exceeded
7	[193.136.92.243]	[193.136.173.30]	ICMP: Echo
8	[193.137.172.254]	[193.136.92.243]	ICMP: Time exceeded
9	[193.136.92.243]	[193.136.173.30]	ICMP: Echo
10	[193.137.172.254]	[193.136.92.243]	ICMP: Time exceeded
11	[193.136.92.243]	[193.136.173.30]	ICMP: Echo
12	[193.137.172.254]	[193.136.92.243]	ICMP: Time exceeded
13	[193.136.92.243]	[193.136.173.30]	ICMP: Echo
14	[193.136.173.30]	[193.136.92.243]	ICMP: Echo reply
15	[193.136.92.243]	[193.136.173.30]	ICMP: Echo
16	[193.136.173.30]	[193.136.92.243]	ICMP: Echo reply
17	[193.136.92.243]	[193.136.173.30]	ICMP: Echo
18	[193.136.173.30]	[193.136.92.243]	ICMP: Echo reply

tracert example

In the above capture, we can check that the display of the *tracert* command is in accordance with the IP addresses of the routers that have replied with ICMP Time Exceeded messages.

ICMP Redirect

- Quando um router deteta que uma estação está a usar uma rota que não é a melhor envia-lhe um mensagem ICMP Redirect para que ele mude de rota
- O router inicial, para além do ICMP Redirect, envia também o datagrama original para o destino
- Não possibilita mudanças de rotas entre routers; apenas entre um host e um router ligados à mesma rede

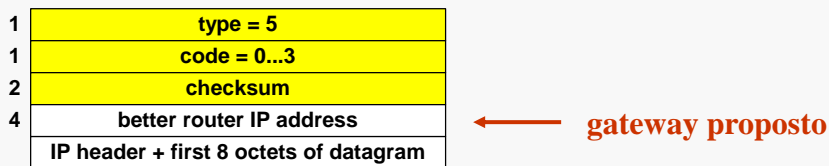

ICMP Redirect message

The ICMP Redirect message is used when a router receives an IP datagram from an host and detects that it is not the appropriate Default Gateway to be used for that IP datagram, i.e. the router checks its routing table and sees that another router exists on the same physical network with a more direct route.

In this situation, the router: (i) forwards the IP datagram to the destination and (ii) sends to the origin host an ICMP Redirect message with the IP address of the other router.

The ICMP Redirect message does not allow to change routes between routers.

The type field of an ICMP Redirect message is 5.

The code field is used to give more information on which IP datagrams should “be redirected”:

Code 0 - Redirect datagrams for the network

Code 1 - Redirect datagrams for the host

Code 2 - Redirect datagrams for the Type of Service and the network

Code 3 - Redirect datagrams for the Type of Service and the host

Exemplo – ICMP Redirect (I)

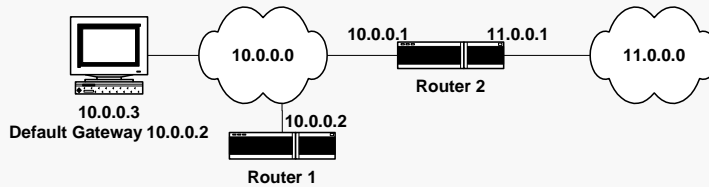

```
=====
Active Routes:
Network Destination    Netmask          Gateway          Interface        Metric
-----
0.0.0.0                0.0.0.0          10.0.0.2         10.0.0.3         1
10.0.0.0               255.0.0.0        10.0.0.3         10.0.0.3         1
10.0.0.3               255.255.255.255  127.0.0.1        127.0.0.1        1
10.255.255.255         255.255.255.255  10.0.0.3         10.0.0.3         1
127.0.0.0              255.0.0.0        127.0.0.1        127.0.0.1        1
224.0.0.0              224.0.0.0        10.0.0.3         10.0.0.3         1
224.0.0.0              224.0.0.0        110.0.0.3        110.0.0.3        1
255.255.255.255       255.255.255.255  10.0.0.3         10.0.0.3         1
=====
```

Tabela de encaminhamento inicial da estação 10.0.0.3

ICMP Redirect example (I)

Consider the above example. Executing the 'route print' command on a DOS window (in the Windows OS) of the host 10.0.0.3, we can check the host routing table. The above routing table is a possible one for the network shown.

Note that if no other line matches a destination IP address, the first line states that the Default Gateway is the host with address 10.0.0.2 (Router 1) that can be reached through output interface 10.0.0.3 (its own network interface).

Exemplo (II)

10.0.0.3
 00-60-97-d4-9c-be
 Default Gateway: 10.0.0.2

10.0.0.0
 00-e0-b0-64-48-76
 Router 2

10.0.0.2
 00-e0-b0-64-48-44
 Router 1

11.0.0.0

Active Routes:

Network	Destination	Netmask	Gateway	Interface	Metric
	0.0.0.0	0.0.0.0	10.0.0.2	10.0.0.3	1
	10.0.0.0	255.0.0.0	10.0.0.3	10.0.0.3	1
	10.0.0.3	255.255.255.255	127.0.0.1	127.0.0.1	1
10.255.255.255	255.255.255.255	255.255.255.255	10.0.0.3	10.0.0.3	1
	11.0.0.1	255.255.255.255	10.0.0.1	10.0.0.3	1
	127.0.0.0	255.0.0.0	127.0.0.1	127.0.0.1	1
	224.0.0.0	224.0.0.0	10.0.0.3	10.0.0.3	1
	224.0.0.0	224.0.0.0	110.0.0.3	110.0.0.3	1
255.255.255.255	255.255.255.255	255.255.255.255	10.0.0.3	10.0.0.3	1

Tabela de encaminhamento final da estação 10.0.0.3

#	Ok	10.0.0.3	11.0.0.1	ICMP	Type=Echo Request, ID=256, Seq No=1280	78
2	Ok	10.0.0.2	10.0.0.3	ICMP	Type=Redirect, Code=for the Host, Gateway IP=10.0.0.1	74
3	Ok	10.0.0.2	10.0.0.3	ICMP	Type=Redirect, Code=for the Net, Gateway IP=10.0.0.1	74
4	Ok	10.0.0.3	11.0.0.1	ICMP	Type=Echo Request, ID=256, Seq No=1280	78
5	Ok	11.0.0.1	10.0.0.3	ICMP	Type=Echo Reply, ID=256, Seq No=1280	78
6	Ok	006097D49CBE	Broadcast	ARP	Op=ARP Request, Src IP=10.0.0.3, Dest IP=10.0.0.1	46
7	Ok	00E0B0644876	006097D49CBE	ARP	Op=ARP Response, Src IP=10.0.0.1, Dest IP=10.0.0.3	64
8	Ok	10.0.0.3	11.0.0.1	ICMP	Type=Echo Request, ID=256, Seq No=1536	78
9	Ok	11.0.0.1	10.0.0.3	ICMP	Type=Echo Reply, ID=256, Seq No=1536	78
10	Ok	10.0.0.3	11.0.0.1	ICMP	Type=Echo Request, ID=256, Seq No=1792	78
11	Ok	11.0.0.1	10.0.0.3	ICMP	Type=Echo Reply, ID=256, Seq No=1792	78
12	Ok	10.0.0.3	11.0.0.1	ICMP	Type=Echo Request, ID=256, Seq No=2048	78
13	Ok	11.0.0.1	10.0.0.3	ICMP	Type=Echo Reply, ID=256, Seq No=2048	78

Pacotes capturados na rede 10.0.0.0

ICMP Redirect example (II)

After running a ping command on host 10.0.0.3 for the remote address 11.0.0.1, the routing table of host 10.0.0.3 has now an additional line stating that the gateway to be used for the destination address 11.0.0.1 is 10.0.0.1.

Analysing the packets captured on network 10.0.0.0, we see that the first ICMP Echo Request is sent to Router 1, this router sends an ICMP Redirect message to the host 10.0.0.3 and forwards the ICMP Echo Request to Router 2. In the next ICMP Echo Requests, they are now sent directly to Router 2.

Router 1 has detected that the IP address 10.0.0.1 is a better route for the destination address 11.0.0.1 because: (i) the outgoing interface to forward the IP datagram is its incoming interface and (ii) its routing table indicates 10.0.0.1 as the next hop router address towards the destination network.

Note that if no ICMP Redirect was issued by Router 1, all IP datagrams sent from host 10.0.0.3 to other networks would be transmitted twice on the network 10.0.0.0.

Subredes

- Uma subrede (subnet) é um subconjunto de uma rede de classe A, B ou C
- A utilização de máscaras, permite que uma rede seja dividida em subredes estendendo a parte de rede à parte de host do endereço IP; esta técnica aumenta o número de redes e reduz o número de hosts

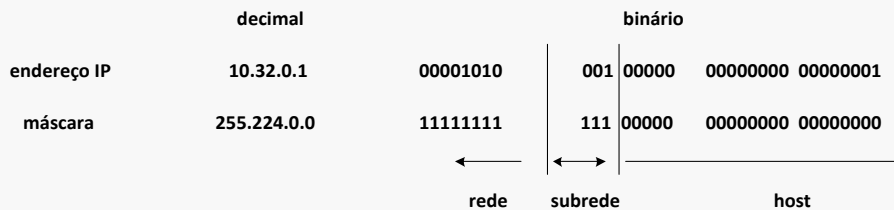

IP subnets

Netmasks give more flexibility to network managers on the usage of the addressing space. A subnet of an original network address is defined when some bits of the original hostid part are used to define the netid part of the address.

In the above example, the IP address 10.32.0.1, defined with netmask 255.224.0.0, uses the first eleven bits to define the netid part and 21 bits to define the hostid part. It is an address defined on a subnet of class A network address 10.0.0.0 since it uses the three most significant bits (assigned with 001) of its hostid part to define the subnet.

In this way, a single class A network address can be organized in smaller subnets to be assigned to different physical networks.

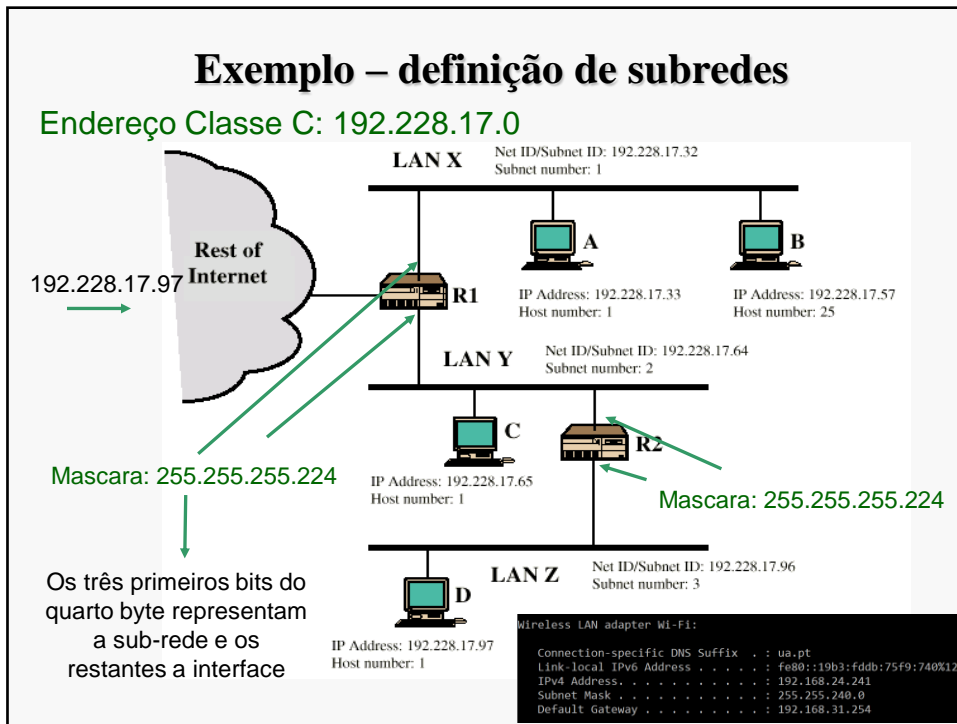

IP subnets example

In the above example, the class C network address 192.228.17.0 (netmask 255.255.255.0) was assigned to a client by its Internet Service Provider (ISP). The client has to assign addresses to hosts but its network is composed by three Local Area Networks (LAN X, LAN Y and LAN Z) separated by 2 routers (R1 and R2). Since it has to assign different netid parts to different LANs, it must resort to the segmentation of the assigned network address into multiple subnets.

By using netmask 255.255.255.224, three additional bits are available for netid definition (in a total of 27 bits). In the above example, the used network addresses are 192.228.17.32 (in LAN X), 192.228.17.64 (in LAN Y) and 192.228.17.96 (in LAN Z). Each host is assigned with an IP address whose 27 first bits (its netid part) are equal to the 27 first bits of its network address. Since there are 5 bits to identify hosts, each host can be identified by a number between 1 and 30 (remember why 0 and 31 cannot be used). The IP address of each host is obtained by adding the assigned number to the IP address of the network (for example, host B has the IP address 192.228.17.57 which results from adding the assigned number 25 to the network address 192.229.17.32).

Questões sobre Máscaras de rede e sub-rede

1. Qual o endereço de broadcast das redes:
 - 200.3.27.128/25
 - 200.3.27.0 e 200.3.27.128 máscara 255.255.248.0?
2. Qual a primeira máquina das redes que têm uma máquina com o endereço:
 - 175.0.92.191/23
 - 175.0.92.190/26
 - 175.0.92.18/28?
3. Qual a última máquina das redes:
 - 175.0.32.0 máscara 255.255.248.0
 - 175.0.0.0 máscara 255.255.224.0
 - 175.0.16.0 máscara 255.255.248.0
4. Quais as redes da máquina:
 - 175.0.22.79/25
 - 175.0.117.215/23
 - 175.0.117.215/27?

Questões sobre Máscaras de rede e sub-rede

5. Quantas redes e com quantas máquinas se obtêm nas redes particionadas como:

- 175.0.4.0 máscara 255.255.255.252
- 175.0.114.0 255.255.255.240?

6. Considere que tem o conjunto de endereços IPv4 de classe C 200.123.189.0/24, que tem de ser usado para as diferentes sub-redes:

- 55 PCs no Networks1 Lab
- 48 PCs no Networks2 Lab
- 45 servidores no Internal Datacenter
- 5 PCs no Professors Lab
- 9 PCs na Administration room.

Define o esquema de endereçamento para as diferentes sub-redes usando os endereços disponíveis.