

External Routing (BGP and MP-BGP)

Redes de Comunicações II

**Licenciatura em
Engenharia de Computadores e Informática
DETI-UA**

Border Gateway Protocol (BGP)

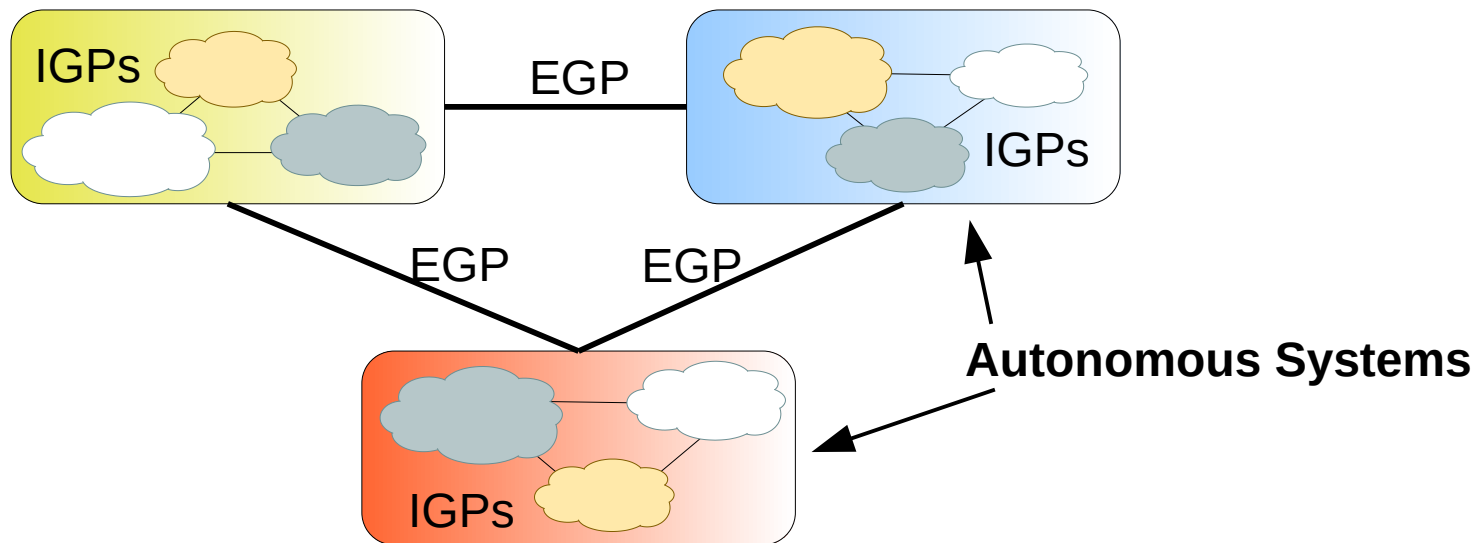

- Border Gateway Protocol Version 4 of the protocol (BGP4) was deployed in 1993 and currently is the protocol that assures Internet connectivity
- BGP is mainly used for routing between Autonomous Systems
- Autonomous System (AS) is a network under a single administration
 - ◆ One or more network operators with a common well defined global routing policy

AS Numbers

- Allocated ID by InterNIC and is globally unique
- RFC 4271 defines an AS number as 2-bytes
 - ◆ Private AS Numbers = 64512 through 65535
 - ◆ Public AS Numbers = 1 through 64511
 - 39000+ have already been allocated
 - We will eventually run out of AS numbers
- Need to expand AS size from 2-bytes to 4-bytes
- RFC4893 defines BGP support for 4-bytes AS numbers
 - ◆ 4,294,967,295 AS numbers
 - ◆ As of January 1, 2009, all new Autonomous System numbers issued will be 4-byte by default, unless otherwise requested.
 - ◆ The full binary 4-byte AS number is split two words of 16 bits each
 - Notation:
 - <higher2bytes in decimal>.<lower2bytes in decimal>
 - Example1: AS 65546 is represented as “1.10”
 - Example2: AS 50000 is represented as “0.50000”
 - ◆ Cannot have a “flag day” solution



BGP Neighbor Relationships

- Often called peering
 - ◆ Usually manually configured into routers by the administrator
- Each neighbor session runs over TCP (port 179)
 - ◆ Ensures reliable data delivery
- Peers exchange all their routes when the session is first established
- Updates are also sent when there is a topology change in the network or a change in routing policy
- BGP peers exchange session KEEPALIVE messages
 - ◆ To avoid extended periods of inactivity.
 - ◆ Low keepalive intervals can be set if a fast fail-over is required



Internal BGP (iBGP) & External BGP (eBGP)

- Neighbor relations can be established between
 - Same AS routers (Internal BGP – iBGP).
 - Different AS routers (External BGP – eBGP).
- Routers that implement neighbor relations are called an Autonomous System Border Router (ASBR).

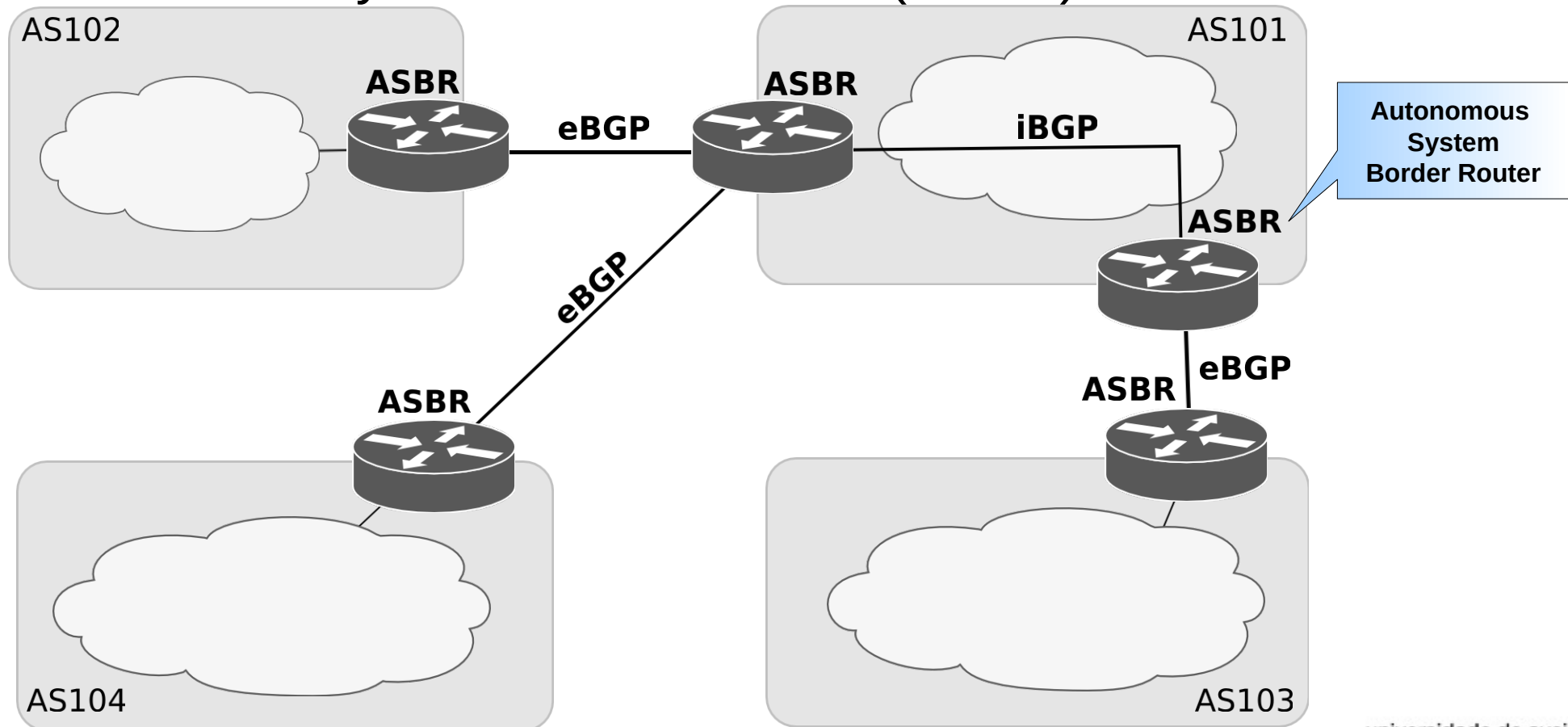

External and Internal BGP

- External BGP (eBGP) is used between AS.
- Internal BGP (iBGP) is used within AS.
- A BGP router never forwards a path learned from one iBGP peer to another iBGP peer even if that path is the best path.
 - An exception is when a router is configured as route-reflector.
- A BGP forward the routes learned from one eBGP peer to both eBGP and iBGP peers.
 - Filters can be used to modify this behavior.
- iBGP routers in an AS **must maintain an iBGP session with all other iBGP routers** in the AS (iBGP Mesh).
 - To obtain complete routing information about external networks.
 - Most networks also use an IGP, such as OSPF.
 - Additional methods can be used to reduce iBGP Mesh complexity.
 - Route reflectors, private AS, ...



Single-homed (or Stub) AS

- AS has only one border router (ASBR)
 - Single Internet access.
 - Single ISP.

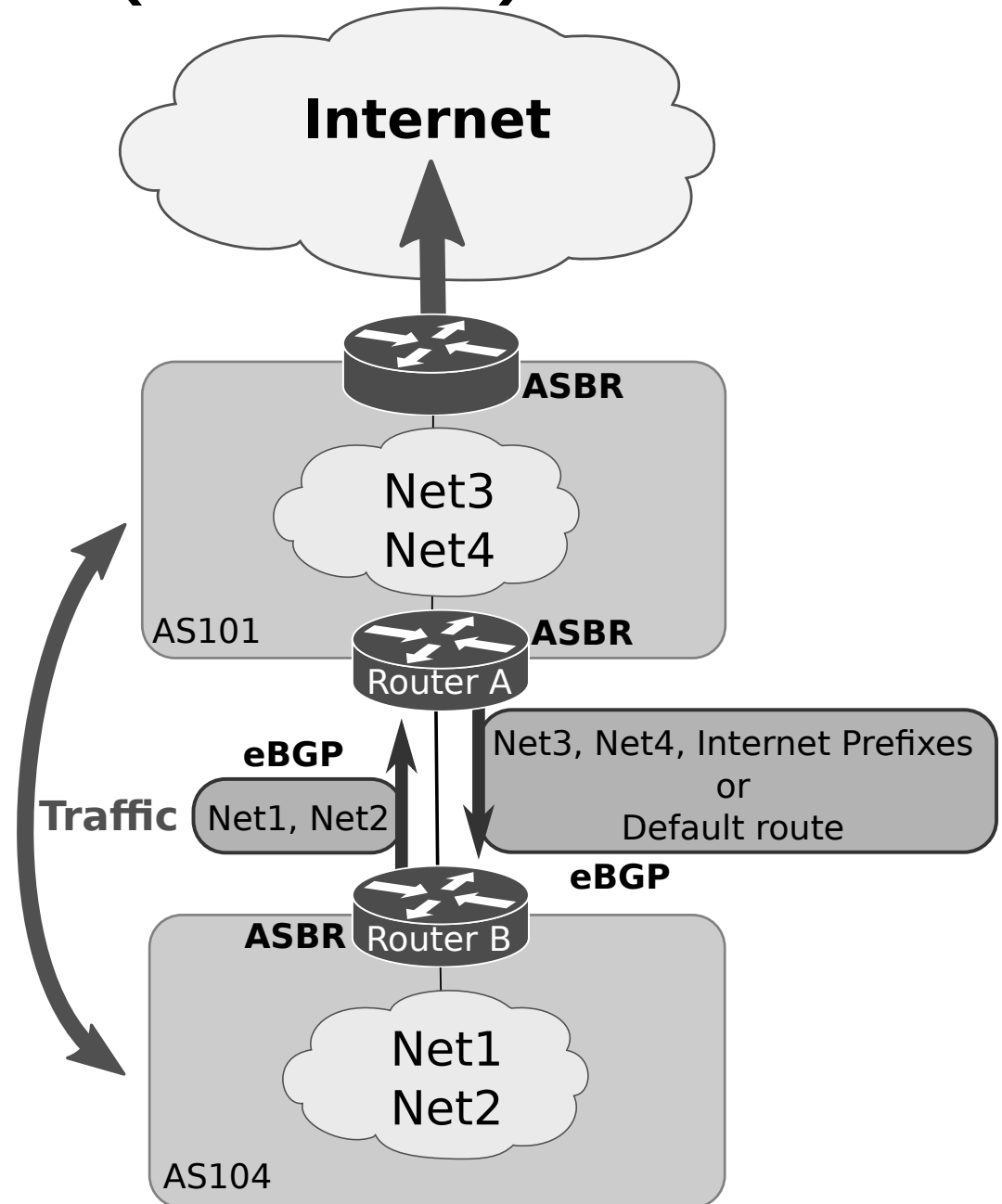

Multi-homed Non-transit AS

- AS has more than one border router (ASBR)
 - Multiple Internet accesses.
 - Multiple ISP.
- Does not transport traffic from other AS.

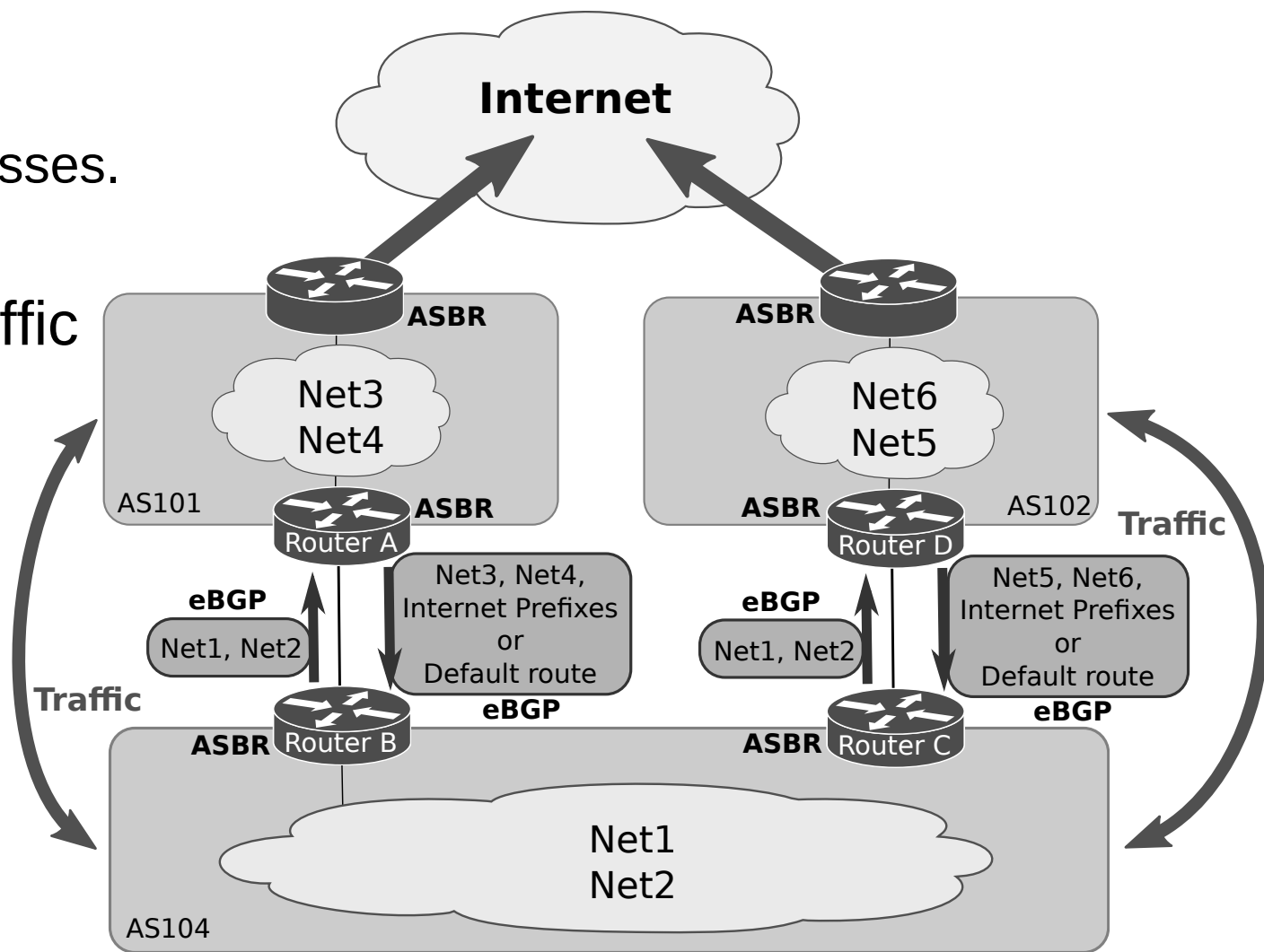

Path-vector

- BGP is a path-vector protocol
- Although it is essentially a distance-vector protocol that carries a list of the AS traversed by the route
 - ◆ Provides loop detection
- An EBGP speaker adds its own AS to this list before forwarding a route to another EBGP peer
- An IBGP speaker does not modify the list because it is sending the route to a peer within the same AS
 - ◆ AS list cannot be used to detect the IBGP routing loops



Path vector

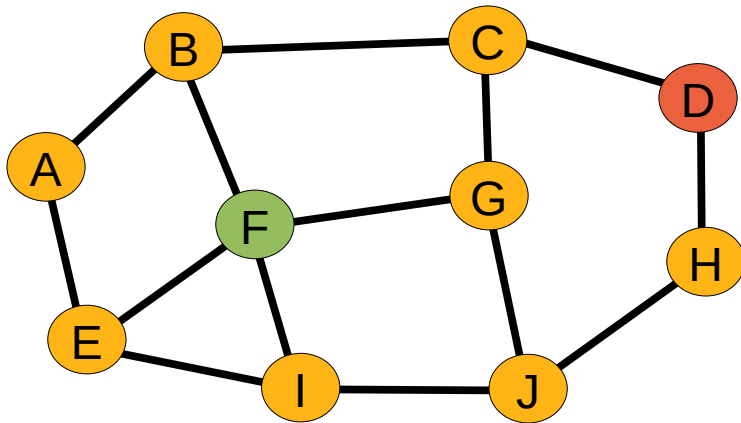

- F receives from its neighbors different paths to D:
 - ◆ De B: “I use BCD”
 - ◆ De G: “I use GCD”
 - ◆ De I: “I use IFGCD”
 - ◆ De E: “I use EFGCD”

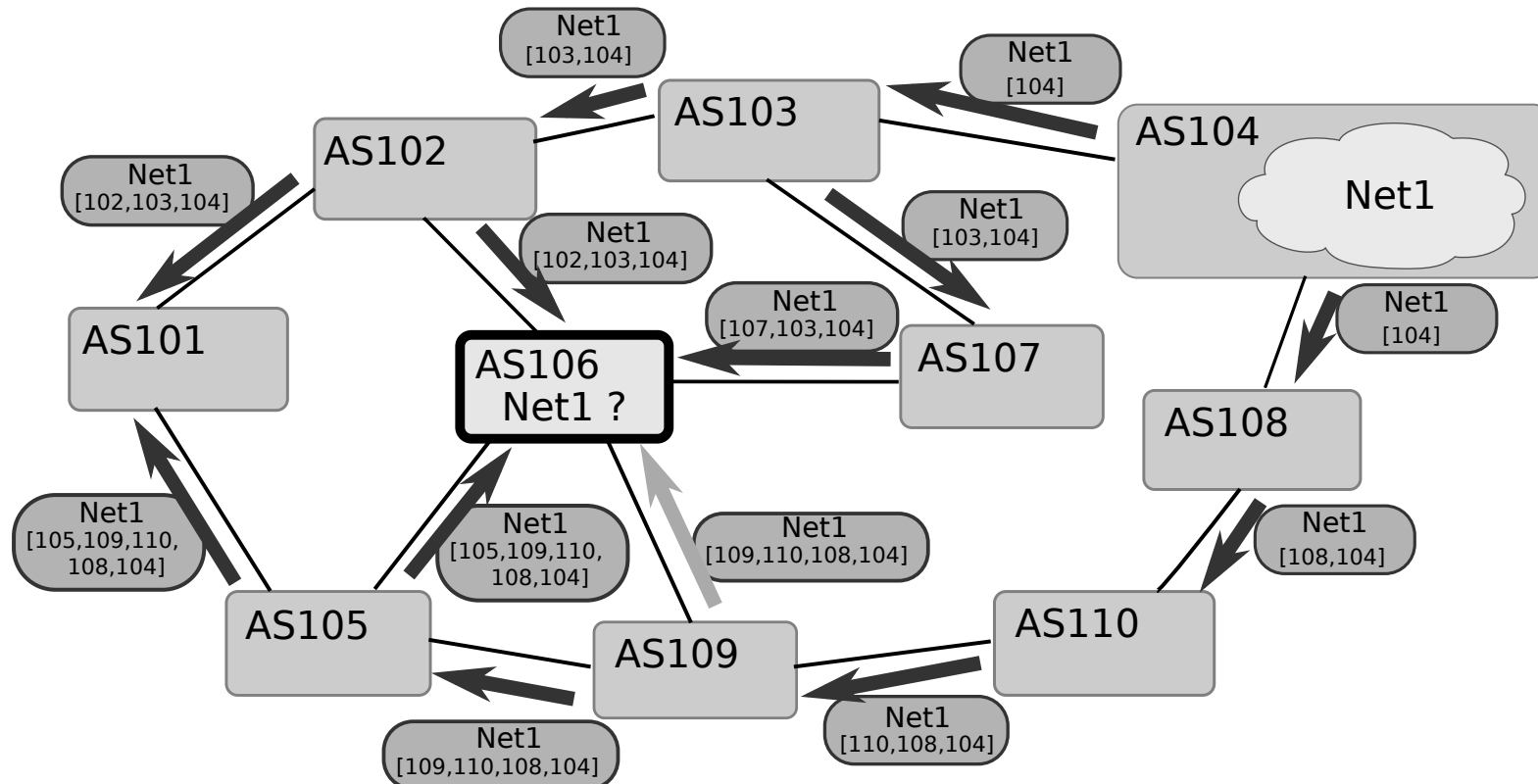

Update Message

- Withdrawn routes – List of IP networks no longer accessible.
- Path attributes – parameters used to define routing and routing policies.
- Network layer reachability information – List of IP networks with connectivity.

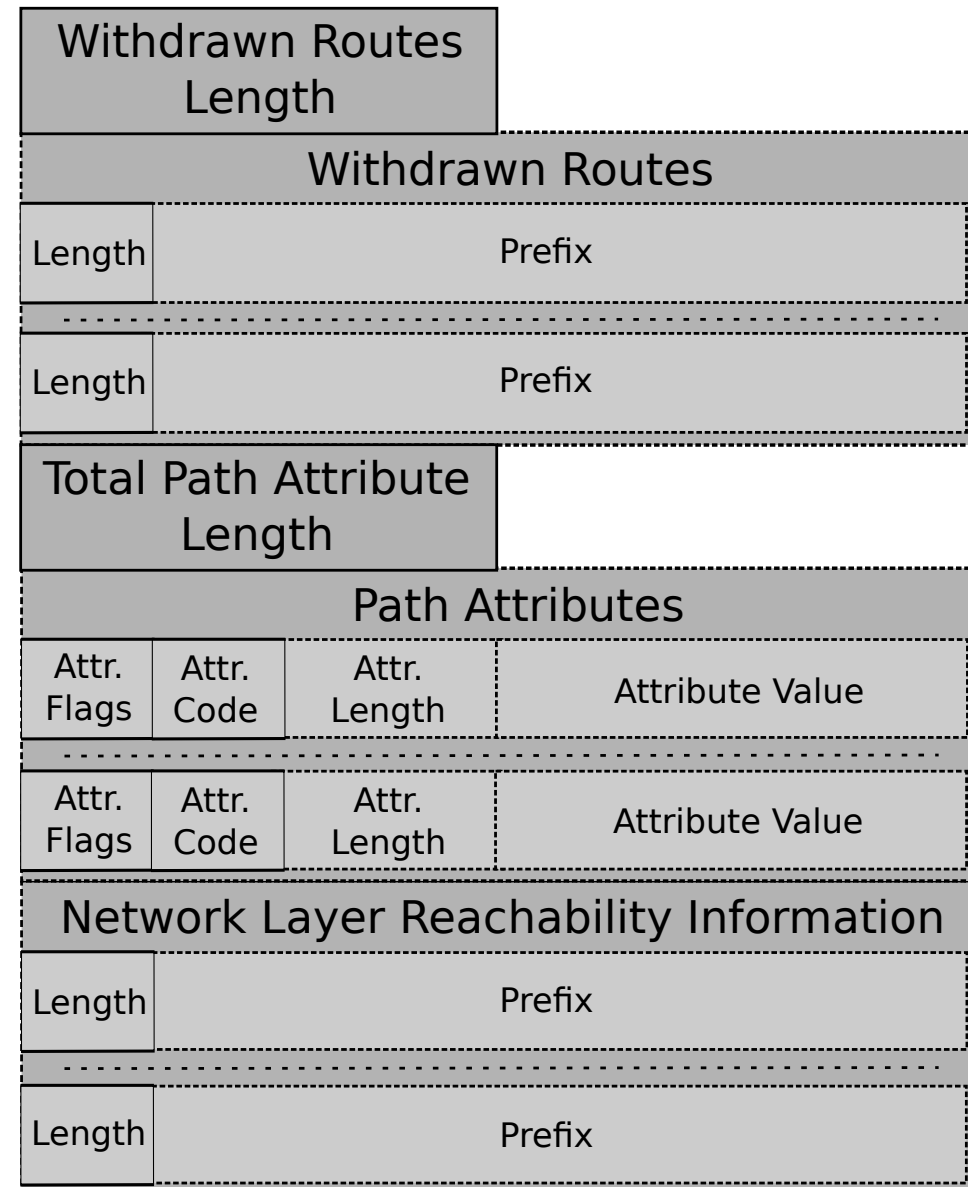

Example

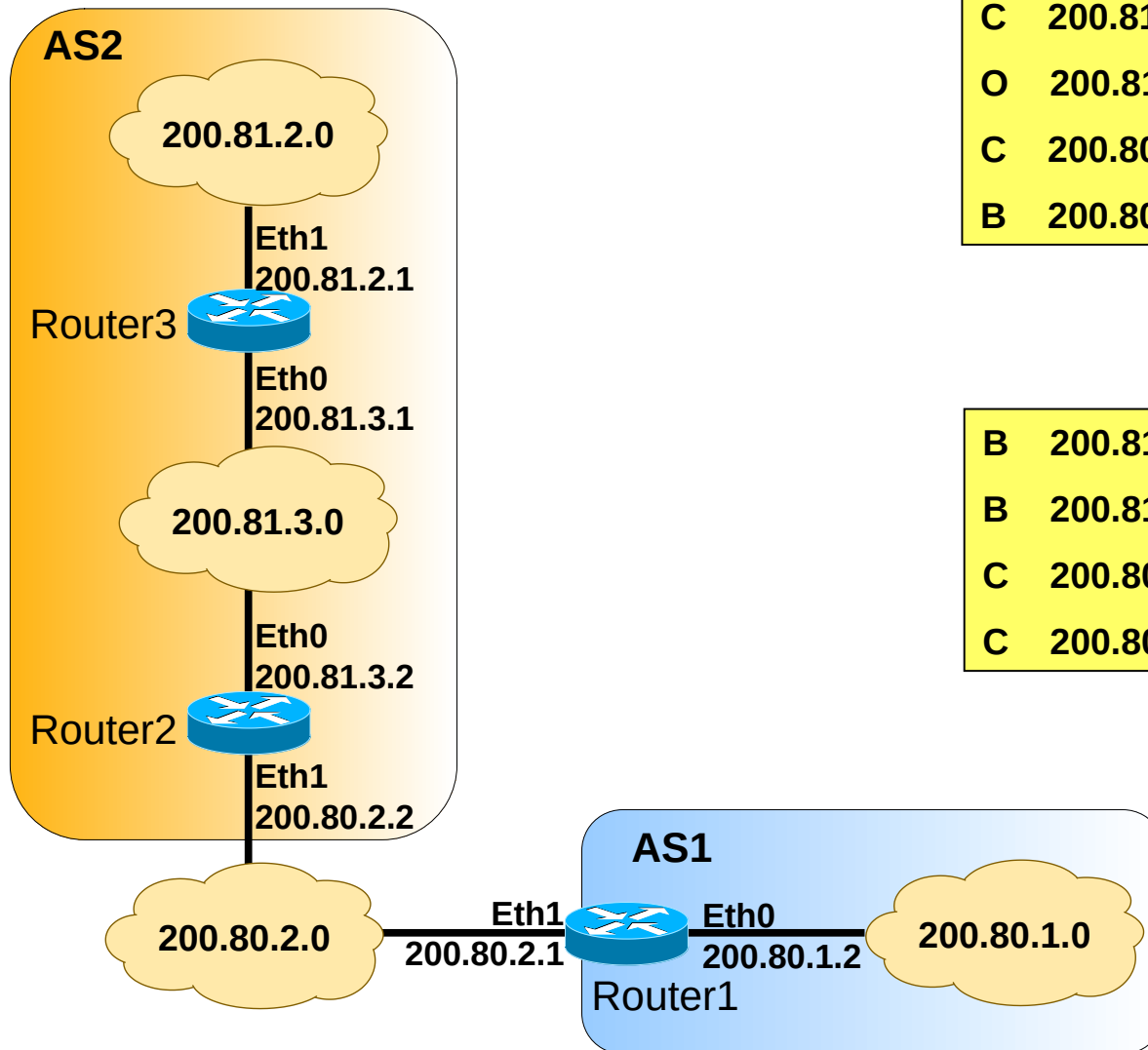

C 200.81.3.0/24 is directly connected, Ethernet0
O 200.81.2.0/24 [110/20] via 200.81.3.1, 00:01:12
C 200.80.2.0/24 is directly connected, Ethernet1
B 200.80.1.0/24 [20/0] via 200.80.2.1, 00:00:29

Router 2's routing table

B 200.81.3.0/24 [20/0] via 200.80.2.2, 00:01:58
B 200.81.2.0/24 [20/0] via 200.80.2.2, 00:01:57
C 200.80.2.0/24 is directly connected, Ethernet1
C 200.80.1.0/24 is directly connected, Ethernet0

Router 1's routing table



Example – BGP networks aggregation

Before aggregation

B 200.81.3.0/24 [20/0] via 200.80.2.2, 00:01:58
B 200.81.2.0/24 [20/0] via 200.80.2.2, 00:01:57
C 200.80.2.0/24 is directly connected, Ethernet1
C 200.80.1.0/24 is directly connected, Ethernet0

Router 1

After aggregation

B 200.81.2.0/23 [20/0] via 200.80.2.2, 00:01:06
C 200.80.2.0/24 is directly connected, Ethernet1
C 200.80.1.0/24 is directly connected, Ethernet0

Router 1

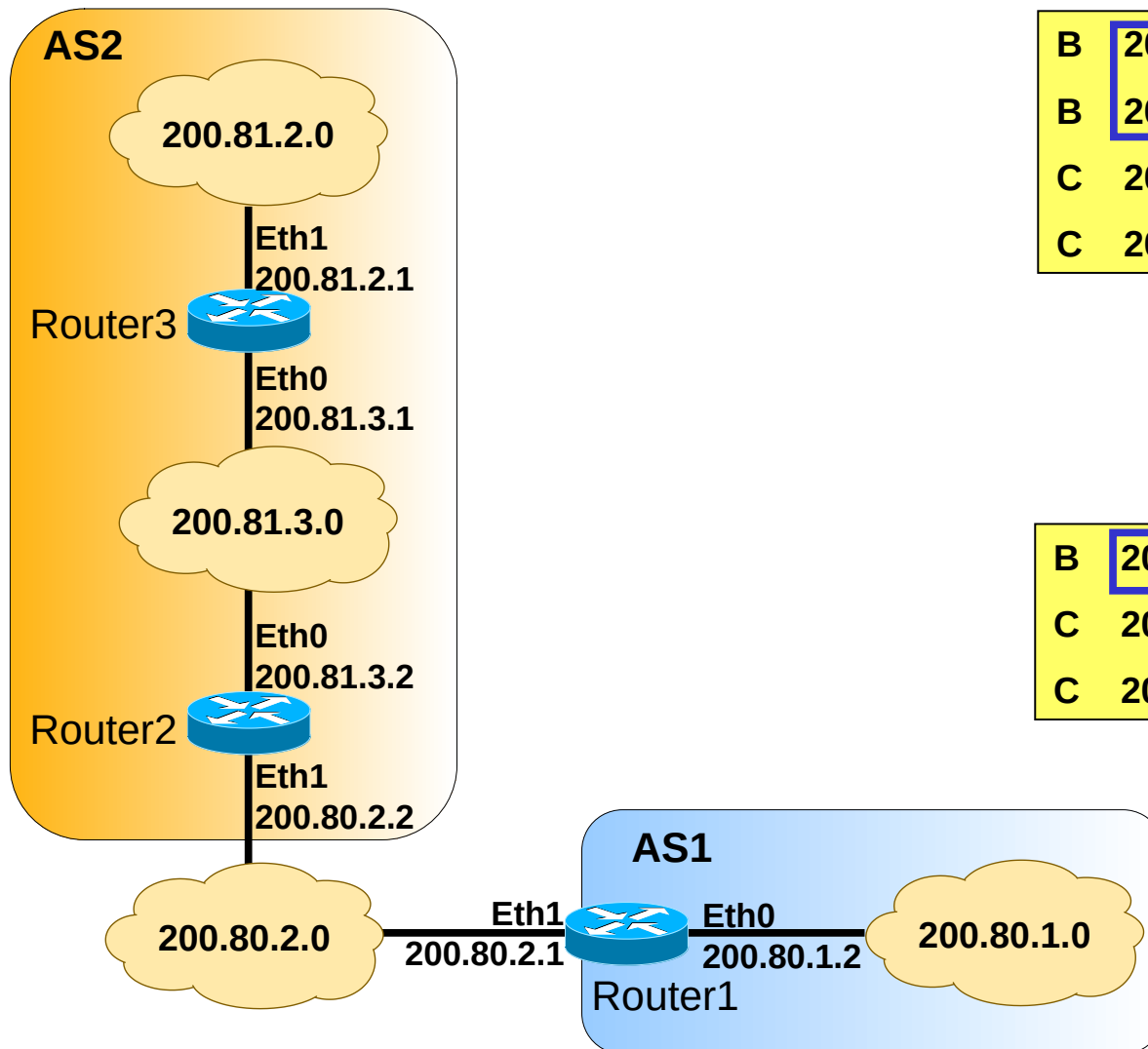

BGP Attributes

- A BGP attribute, or path attribute, is a metric used to describe the characteristics of a BGP path.
- Attributes are contained in update messages passed between BGP peers to advertise routes. There are 4+1 categories of BGP attributes.
 - ◆ Well-known Mandatory (included in BGP updates)
 - AS-path, Next-hop, Origin.
 - ◆ Well-known Discretionary (may or may not be included in BGP updates)
 - Local Preference, Atomic Aggregate.
 - ◆ Optional Transitive (may not be supported by all BGP implementations)
 - Aggregator, Community, AS4_Aggregator, AS4_path.
 - ◆ Optional Non-transitive (may not be supported by all BGP implementations)
 - If the neighbor doesn't support that attribute it is deleted
 - Multi-exit-discriminator (MED).
 - ◆ Cisco-defined (local to router, not advertised)
 - Weight



AS-PATH and ORIGIN Attributes

- AS-PATH

- When a route advertisement passes through an autonomous system, the AS number is added to an ordered list of AS numbers that the route advertisement has traversed.

- ORIGIN

- Indicates how BGP learned about a particular route. Can take three possible values:
 - IGP (0) value is set if the route is interior to the originating AS, resulting from an explicit inclusion of a network within the BGP routing process by means of manual configuration.
 - INCOMPLETE (2) value is set if the route is learned by other means, namely, route redistribution from other routing processes into the BGP routing process.
 - EGP (1) is no longer used in modern networks.



AS4_PATH & AS4_AGGREGATOR

- AS4_PATH attribute has the same semantics as the AS_PATH attribute, except that it is optional transitive, and it carries 4-bytes AS numbers.
- AS4_AGGREGATOR attribute has the same semantics as the AGGREGATOR attribute, except that it carries a 4-bytes AS number.
- 4-byte AS support is advertised via BGP capability negotiation
 - ◆ Speakers who support 4-byte AS are known as NEW BGP speakers
 - ◆ Those who do not are known as OLD BGP speakers
- New Reserved AS number
 - ◆ AS_TRANS = AS 23456
 - 2-byte placeholder for a 4-byte AS number
 - Used for backward compatibility between OLD and NEW BGP speakers
- Receiving UPDATES from a NEW speaker
 - ◆ Decode each AS number as 4-bytes
 - ◆ AS_PATH and AGGREGATOR are effected
- Receiving UPDATES from an OLD speaker
 - ◆ AS4_AGGREGATOR will override AGGREGATOR
 - ◆ AS4_PATH and AS_PATH must be merged to form the correct as-path
- Merging AS4_PATH and AS_PATH
 - ◆ AS_PATH → [275 250 225 23456 23456 200 23456 175]
 - ◆ AS4_PATH → [100.1 100.2 200 100.3 175]
 - ◆ Merged AS-PATH → [275 250 225 100.1 100.2 200 100.3 175]



4-bytes AS Operational Example

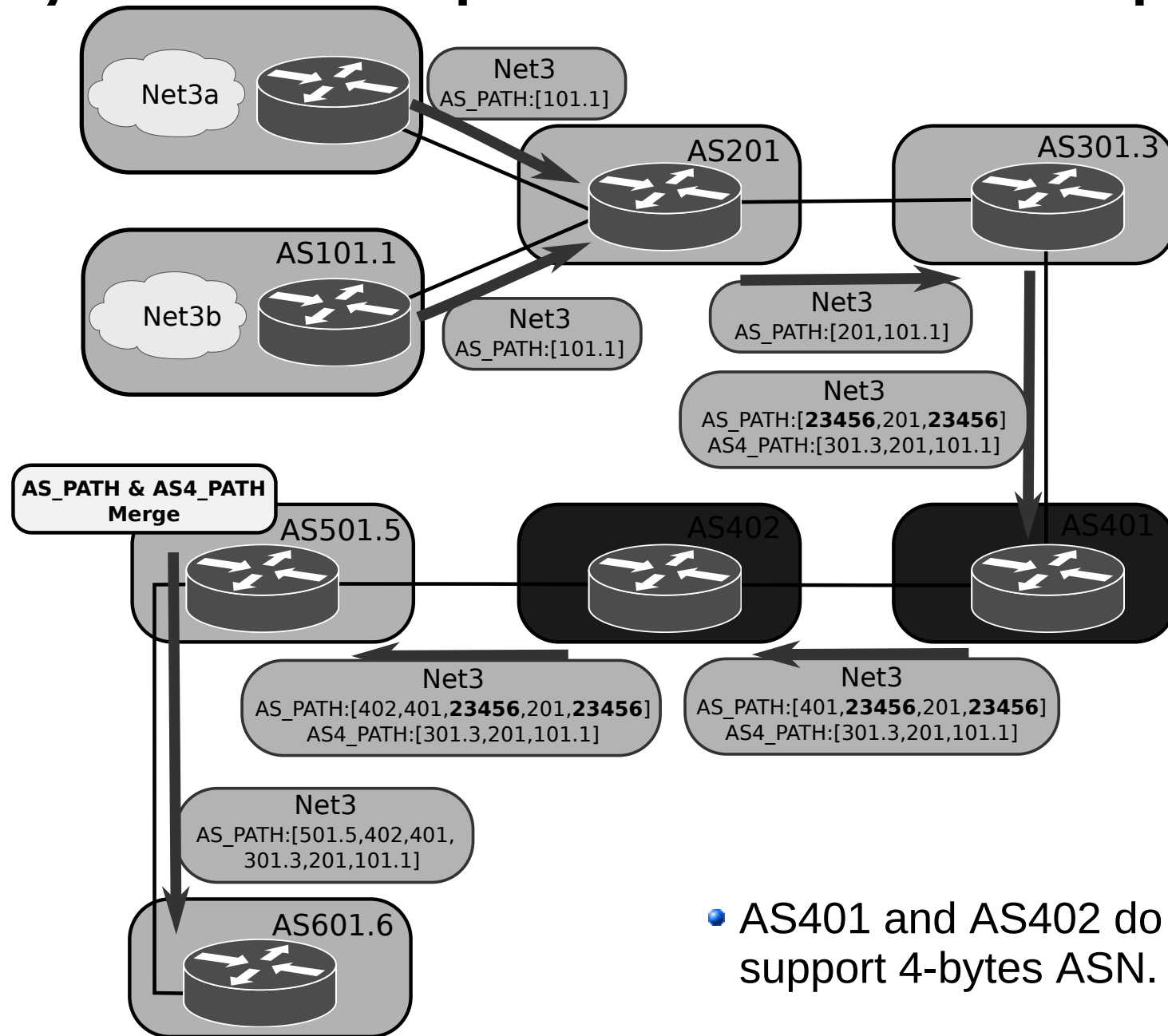

- AS401 and AS402 do not support 4-bytes ASN.



Next-Hop Attribute

- The eBGP next-hop attribute is the IP address that is used to reach the advertising router
- For eBGP, the next-hop address is the IP address of the connection between the peers
- For iBGP, the eBGP next-hop address is carried into the local AS
 - ◆ By configuration the AS border router can be the next-hop to iBGP neighbors

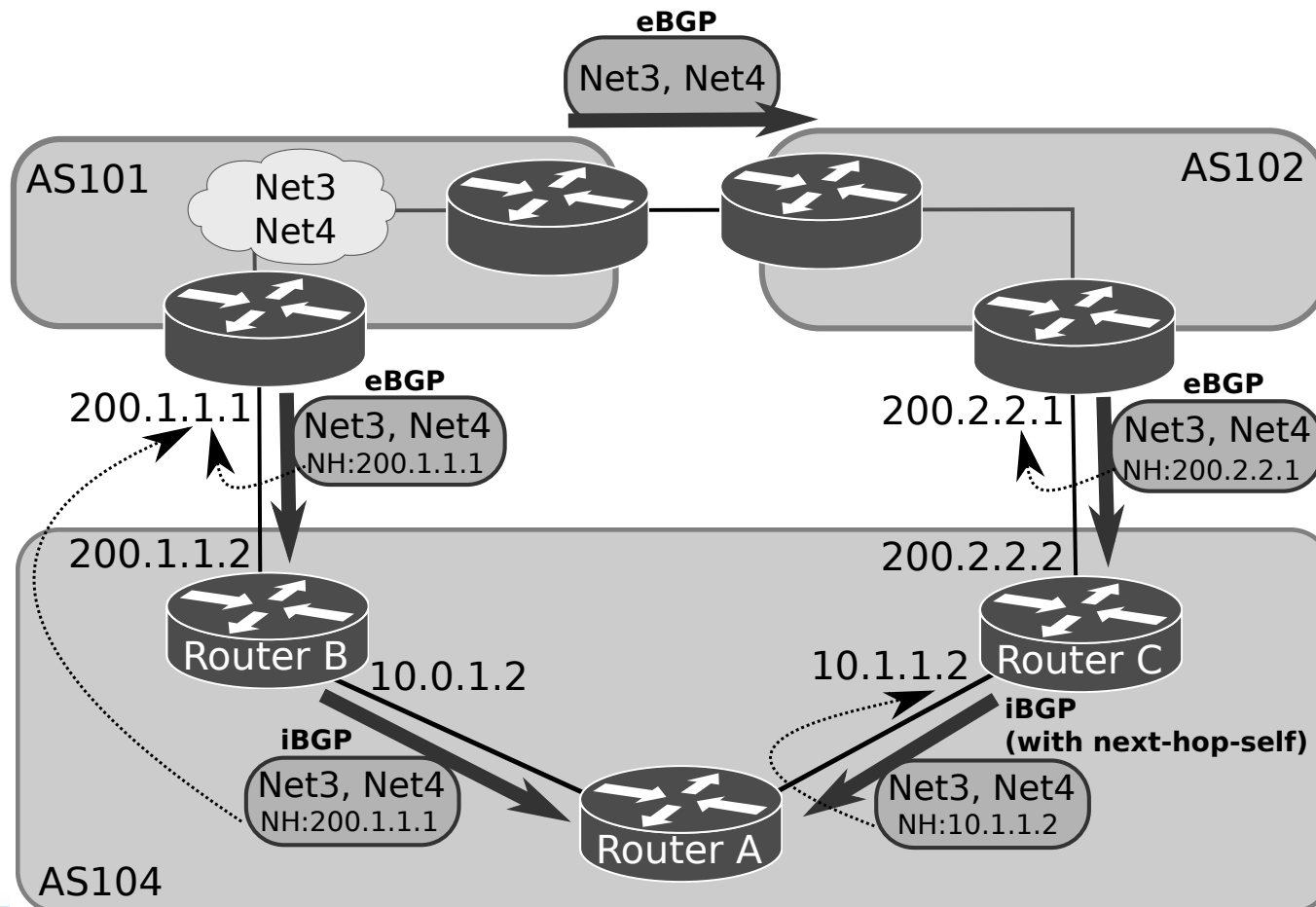

Local Preference Attribute

- The local preference attribute is used to choose an exit point from the local autonomous system (AS).
 - **Higher value** is preferred.
- The local preference attribute is propagated throughout the local AS.
- Can be different for different routes

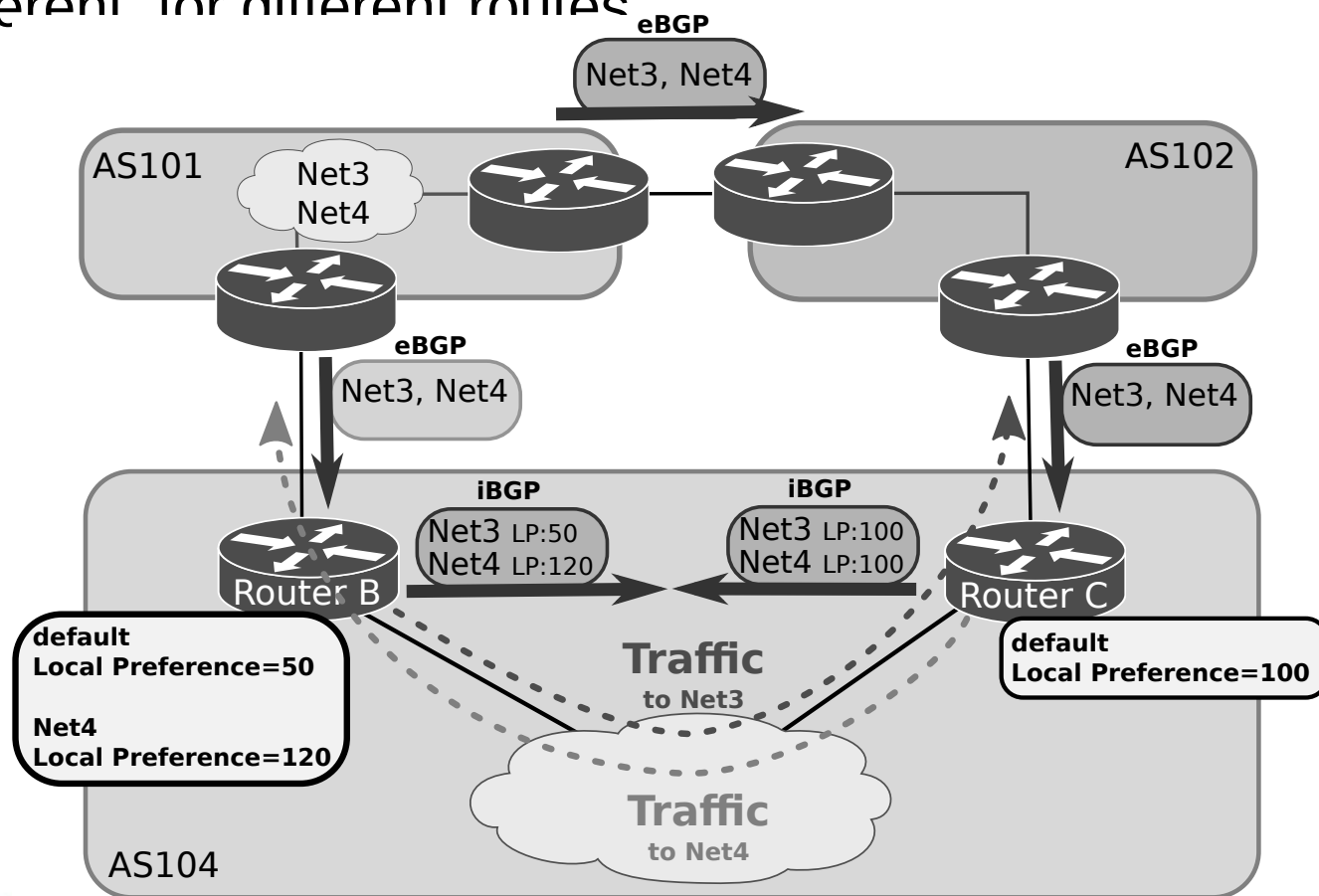

Multi-Exit Discriminator Attribute (MED)

- The multi-exit discriminator (MED) or metric attribute is used as a suggestion to an external AS.
- The external AS that is receiving the MEDs may be using other BGP attributes for route selection.
- The **lower value** of the metric is preferred.
- MED is designed to influence incoming traffic.

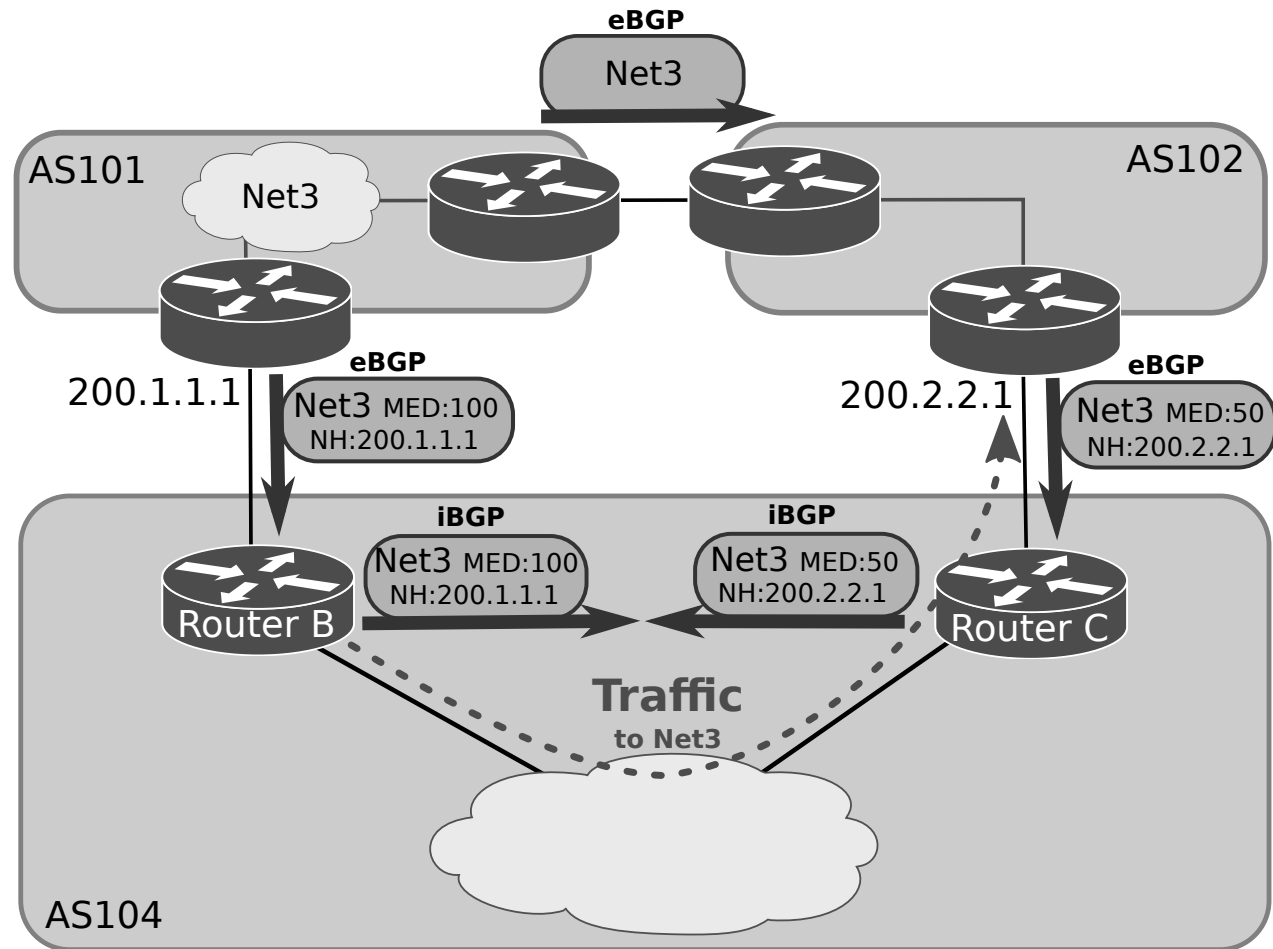

Weight Attribute

- Weight is a Cisco-defined attribute that is local to a router.
- The weight attribute is not advertised to neighboring routers.
- If the router learns about more than one route to the same destination, the route with the **highest weight** will be preferred.

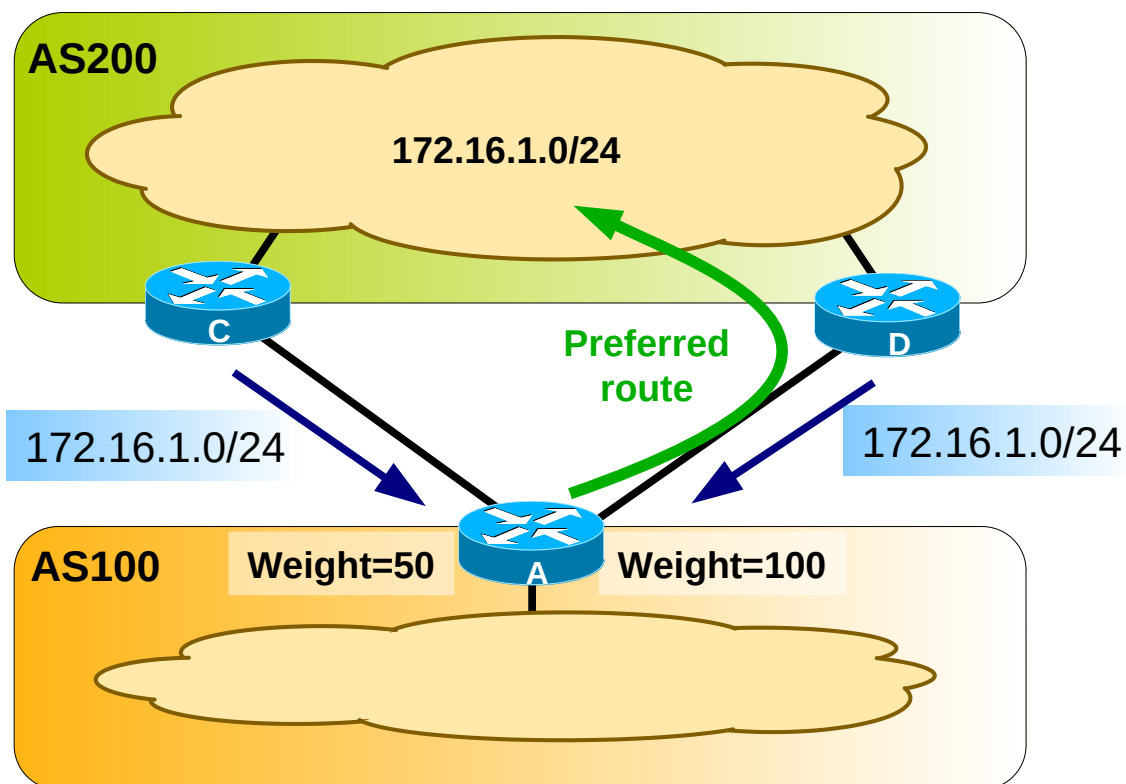

Atomic Aggregate and Aggregator Attributes

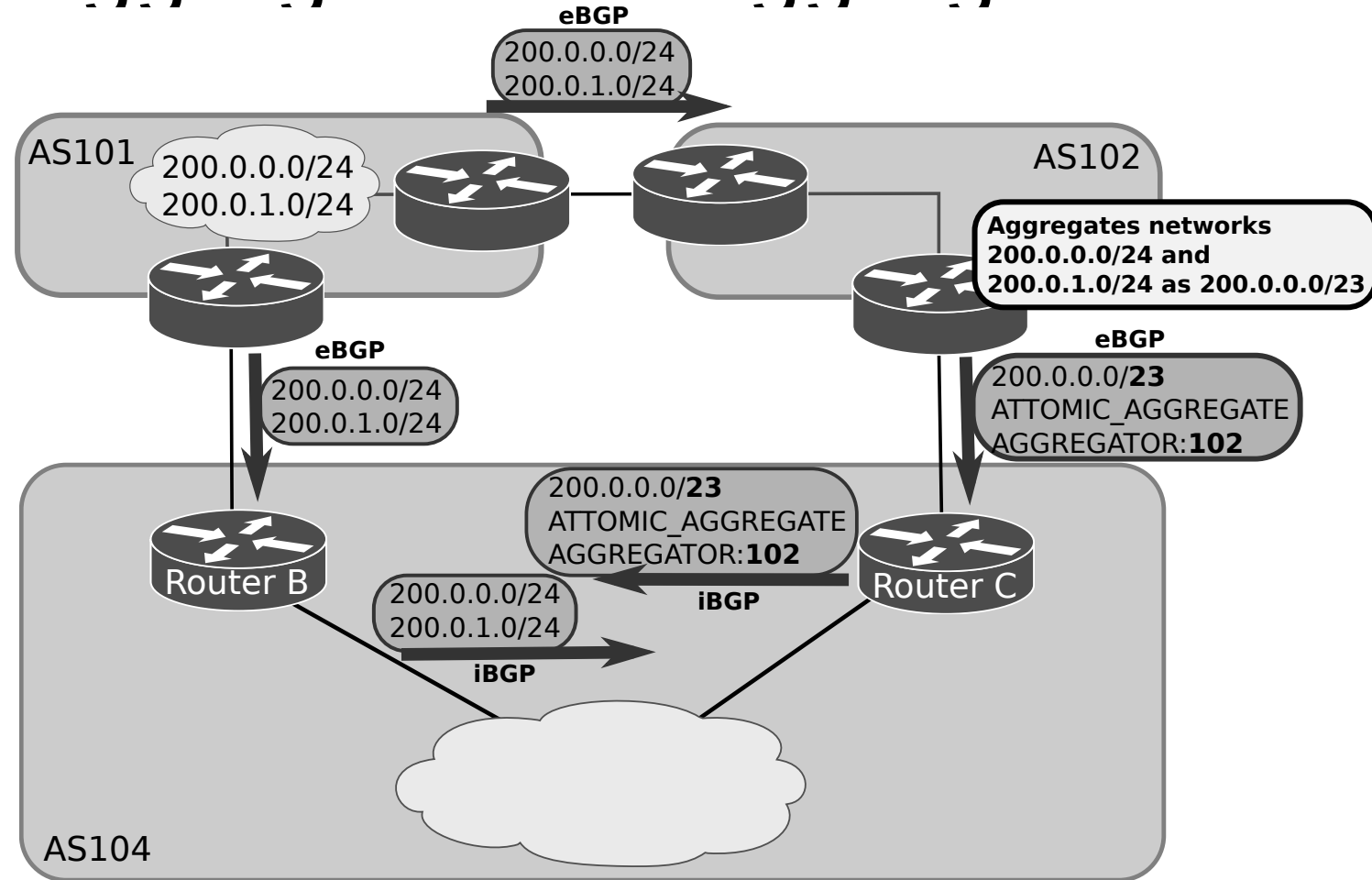

- Atomic Aggregate
 - ◆ Is used to alert routers that specific routes have been aggregated into a less specific route.
 - ◆ When aggregation like this occurs, more specific routes are lost.
- Aggregator
 - ◆ Provides information about which AS performed the aggregation.
 - ◆ And the IP address of the router that originated the aggregate.



Community Attribute

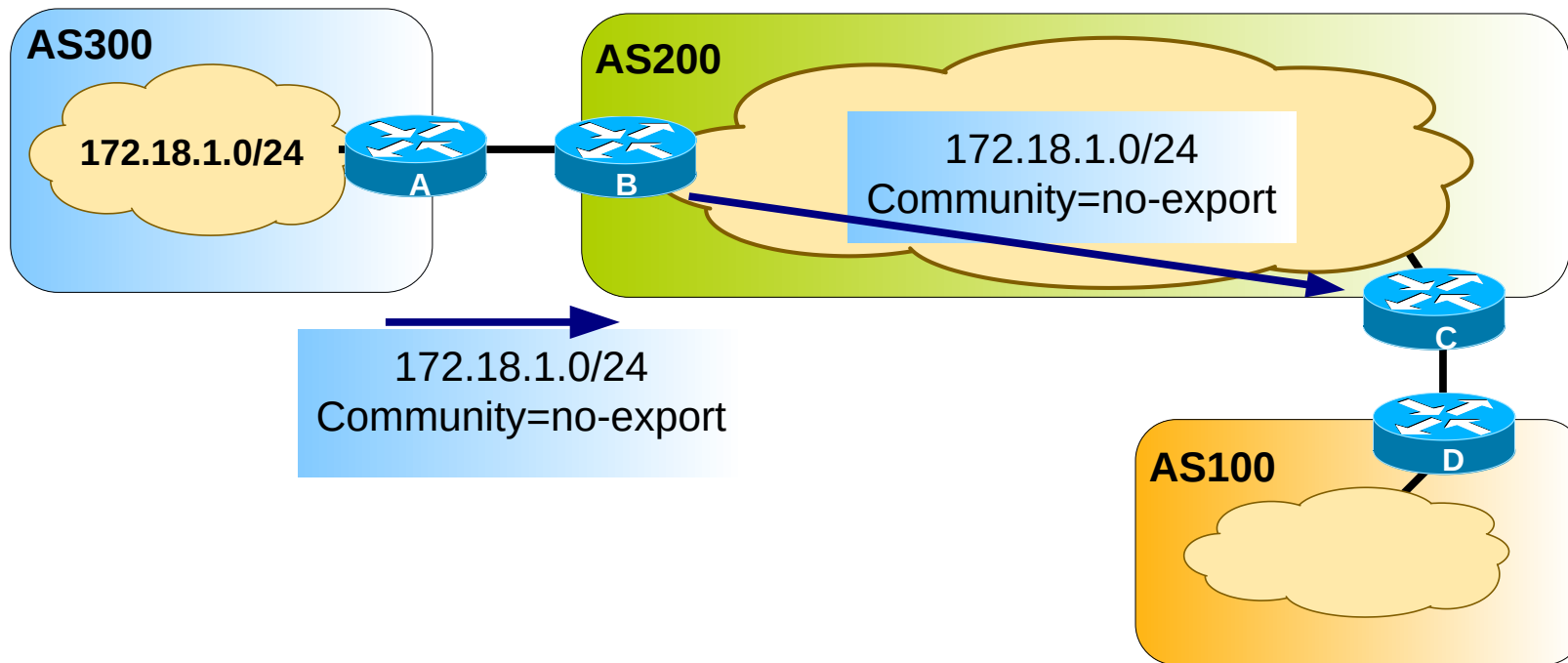

- Used to group routes that share common properties so that policies can be applied at the group level
- Predefined community attributes are:
 - ◆ no-export - Do not advertise this route to EBGp peers
 - ◆ no-advertise - Do not advertise this route to any peer
 - ◆ internet - Advertise this route to the Internet community; all routers in the network belong to it
- General communities format is ASnumber:Cnumber
 - ◆ e.g. 300:1, 200:38, etc...



BGP Path Selection

- BGP may receive multiple advertisements for the same route from multiple sources.
- BGP selects only one path as the best path.
- BGP puts the selected path in the IP routing table and propagates the path to its neighbors. BGP uses the following criteria, in the order:
 - ◆ Largest weight (Cisco only)
 - ◆ Largest local preference
 - ◆ Path that was originated locally
 - ◆ Shortest path
 - ◆ Lowest origin type (IGP lower than EGP, EGP lower than incomplete)
 - ◆ Lowest MED attribute
 - ◆ Prefer the external path over the internal path
 - ◆ Closest IGP neighbor



Multi-Protocol Border Gateway Protocol (MP-BGP)



MP-BGP Description

- Extension to the BGP protocol
- Carries routing information about other protocols/families:
 - ◆ IPv6 Unicast
 - ◆ Multicast (IPv4 and IPv6)
 - ◆ 6PE - IPv6 over IPv4 MPLS backbone
 - ◆ Multi-Protocol Label Switching (MPLS) VPN (IPv4 and IPv6)
- Exchange of Multi-Protocol Reachability Information (NLRI)



MP-BGP Attributes

- New non-transitive and optional attributes
 - ◆ MP_REACH_NLRI
 - Carry the set of reachable destinations together with the next-hop information to be used for forwarding to these destinations
 - ◆ MP_UNREACH_NLRI
 - Carry the set of unreachable destinations
- Attribute contains one or more triples
 - ◆ Address Family Information (AFI) with Sub-AFI
 - Identifies protocol information carried in the Network Layer Reachability Information
 - ◆ Next-hop information
 - Next-hop address must be of the same family
- Reachability information



MP-BGP Negotiation Capabilities

- MP-BGP routers establish BGP sessions through the OPEN message
 - OPEN message contains optional parameters
 - If OPEN parameters are not recognized, BGP session is terminated
 - A new optional parameter: CAPABILITIES
- OPEN message with CAPABILITIES containing:
 - Multi-Protocol extensions (AFI/SAFI)
 - Route Refresh
 - Outbound Route Filtering



MP-BGP New Features for IPv6

- IPv6 Unicast
 - MP-BGP enables the creation of IPv6 Inter-AS relations
- IPv6 Multicast
 - Unicast prefixes for Reverse Path Forwarding (RPF) checking
 - RPF information is disseminated between autonomous systems
 - Compatible with single domain Rendezvous Points or Protocol Independent Multicast-Source Specific Multicast (PIM-SSM)
 - Topology can be congruent or non-congruent with the unicast one
- IPv6 and label (6PE)
 - IPv6 packet is transported over an IPv4 MPLS backbone
- IPv6 VPN (6VPE)
 - Multiple IPv6 VPNs are created over an IPv4 MPLS backbone



Private BGP AS

- Private autonomous system (AS) numbers range from 64512 to 65535
- When a customer network is large, the ISP may assign an AS number:
 - ◆ Permanently assigning a **Public** AS number in the range of 1 to 64511
 - ➔ Should have a unique AS number to propagate its BGP routes to Internet
 - ➔ Done when a customer network connects to two different ISPs, such as multihoming
 - ◆ Assigning a **Private** AS number in the range of 64512 to 65535.
 - ➔ It is not recommended that you use a private AS number when planning to connect to multiple ISPs in the future

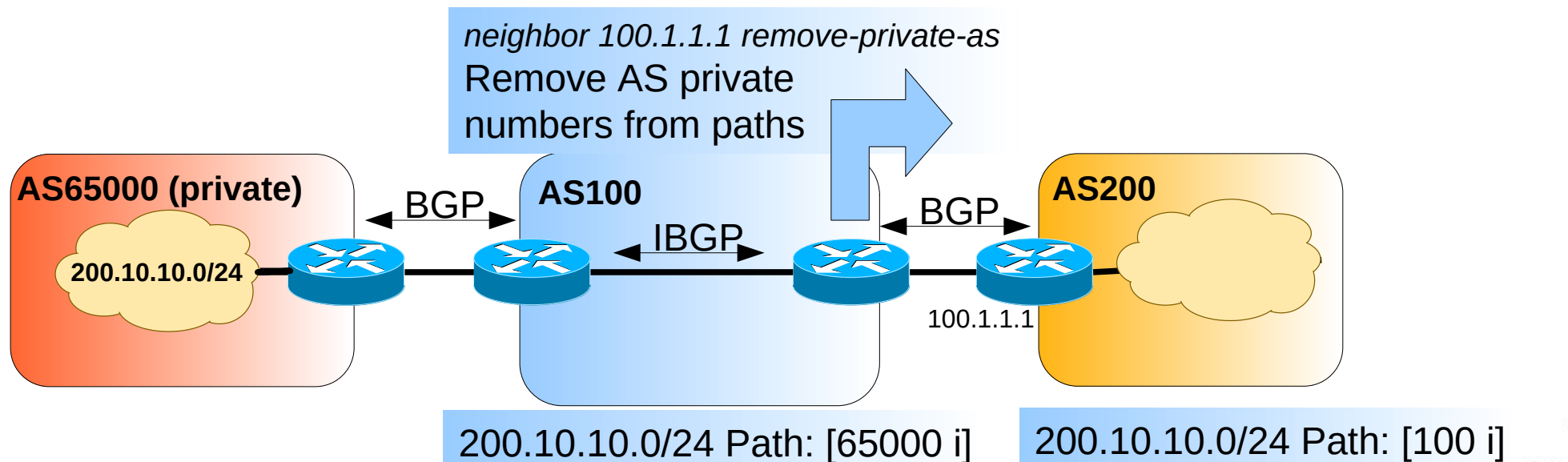

BGP AS Routing Policies

```
aut-num: AS15525
as-name: PTPRIMENET
descr: PT Prime Autonomous System
descr: Corporate Data Communications Services
descr: Portugal
import: from AS1930 action pref=100;
       accept AS-RCCN # RCCN
import: from AS3243 action pref=200;
       accept AS-TELEPAC # Telepac
import: from AS5516 action pref=100;
       accept AS5516 # INESC
import: from AS5533 action pref=100;
       accept AS-VIAPT # Via NetWorks Portugal
import: from AS8657 action pref=300;
       accept ANY # CPRM
import: from AS12305 action pref=100;
       accept AS12305 # Nortenet
import: from AS1897 action pref=100;
       accept AS1897 AS9190 AS13134 AS15931 # KPN Qwest
import: from AS13156 action pref=100;
       accept AS13156 # Cabovisao
import: from AS8824 action pref=100;
       accept AS8824 AS15919 # Eastecnica
.....
```

```
export: to AS1897 announce RS-PTPRIME # KPNQwest
export: to AS1930 announce RS-PTPRIME # RCCN
export: to AS3243 announce RS-PTPRIME # Telepac
export: to AS5516 announce {0.0.0.0/0} # INESC
export: to AS5533 announce RS-PTPRIME # Via NetWorks
Portugal
export: to AS8657 announce RS-PTPRIME # CPRM
export: to AS8824 announce RS-PTPRIME # Eastecnica
export: to AS8826 announce {0.0.0.0/0} # Siemens
export: to AS9186 announce RS-PTPRIME # ONI
export: to AS12305 announce RS-PTPRIME # Nortenet
export: to AS12353 announce RS-PTPRIME # Vodafone Portugal
export: to AS13156 announce RS-PTPRIME # Cabovisao
export: to AS13910 announce ANY # register.com
export: to AS15931 announce ANY # YASP Hiperbit
export: to AS24698 announce RS-PTPRIME # Optimus
export: to AS25005 announce ANY # Finibanco
export: to AS25253 announce {0.0.0.0/0} # CGDNet
export: to AS28672 announce ANY # BPN
export: to AS31401 announce {0.0.0.0/0} # SICAMSERV
export: to AS39088 announce {0.0.0.0/0} # Santander-Totta
export: to AS41345 announce RS-PTPRIME # Visabeira
export: to AS43064 announce RS-PTPRIME # Teixeira Duarte
export: to AS43643 announce ANY # TAP
.....
```

From RIPE database
<http://www.db.ripe.net>



BGP Route Reflectors

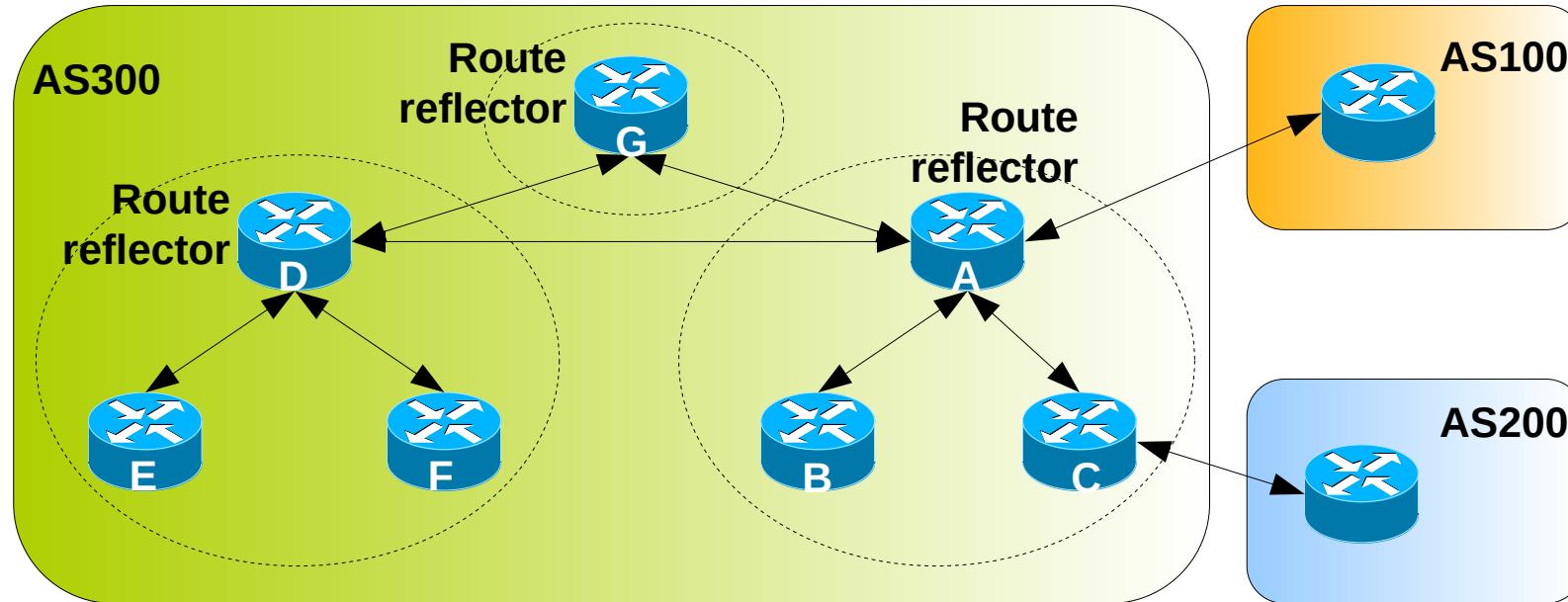

- Without a route reflector, the network requires a full iBGP mesh within AS300.
- The route reflector and its clients are called a cluster.
 - Router A is configured as a route reflector, iBGP peering between Routers B and C (and others) is not required.
 - Router D is configured as a route reflector, iBGP peering between Routers E and F (and others) is not required.
- Full iBGP mesh between route reflector Routers.

Routes Redistribution

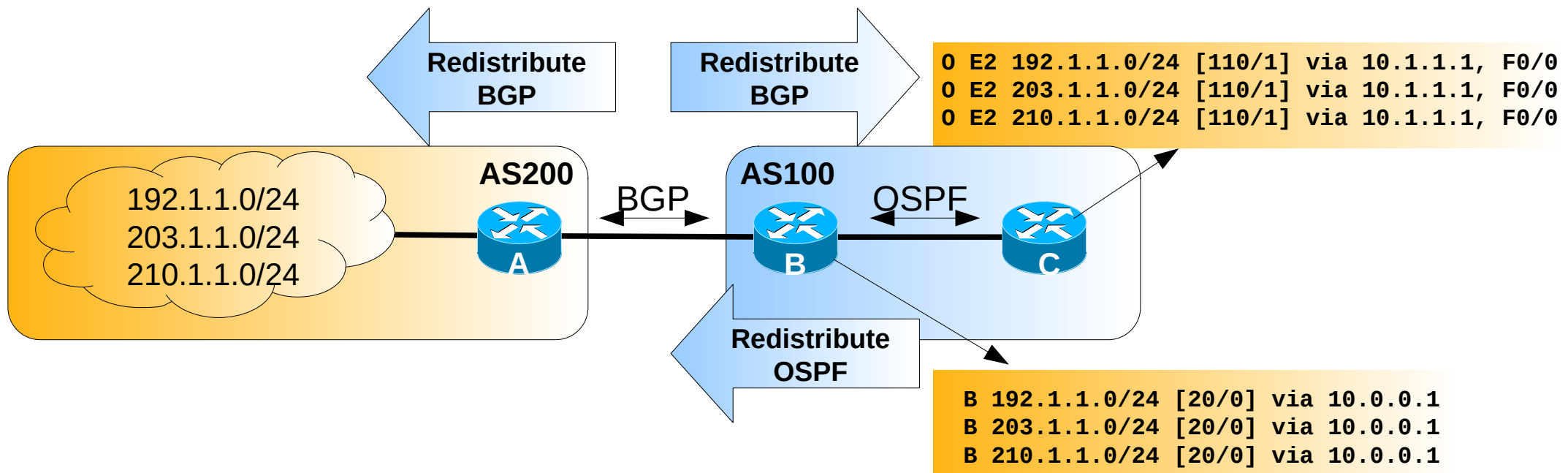

- Redistributing IGP routes by BGP will:
 - Simplify BGP configuration (advantage)
 - And BGP will announce only internal networks with connectivity (advantage)
- Redistributing BGP routes by IGP protocols will:
 - Make internal routes know all external routes (disadvantage/advantage?)
 - Increase routing tables size in internal routers (disadvantage)
 - Decrease routing time, imposes memory requirements, ...
 - Avoid the usage of internal default routes (disadvantage/advantage?)



BGP Filtering

- By default BGP processes announce every network path that receives
 - ◆ From other BGP peers, or
 - ◆ Redistributed internal routing processes.
- Sending and receiving BGP updates can be controlled by using a number of different filtering methods.
 - ◆ Route-maps, prefix-lists, distribution-lists.
- BGP updates can be filtered based on:
 - ◆ Route information,
 - ◆ Path information,
 - ◆ Communities.
- Actions:
 - ◆ Change local-preference to define the preferred paths.
 - Preferred paths should have the higher local-preference.
 - ◆ Block/Deny paths to not even consider such path for routing.
- Best practices:
 - ◆ Block all IPv4 private networks,
 - ◆ Announce default routes only to peers where a traffic transport contract exists.
 - ◆ Accept default routes only from peers that provide a traffic transport service.



BGP Case Studies

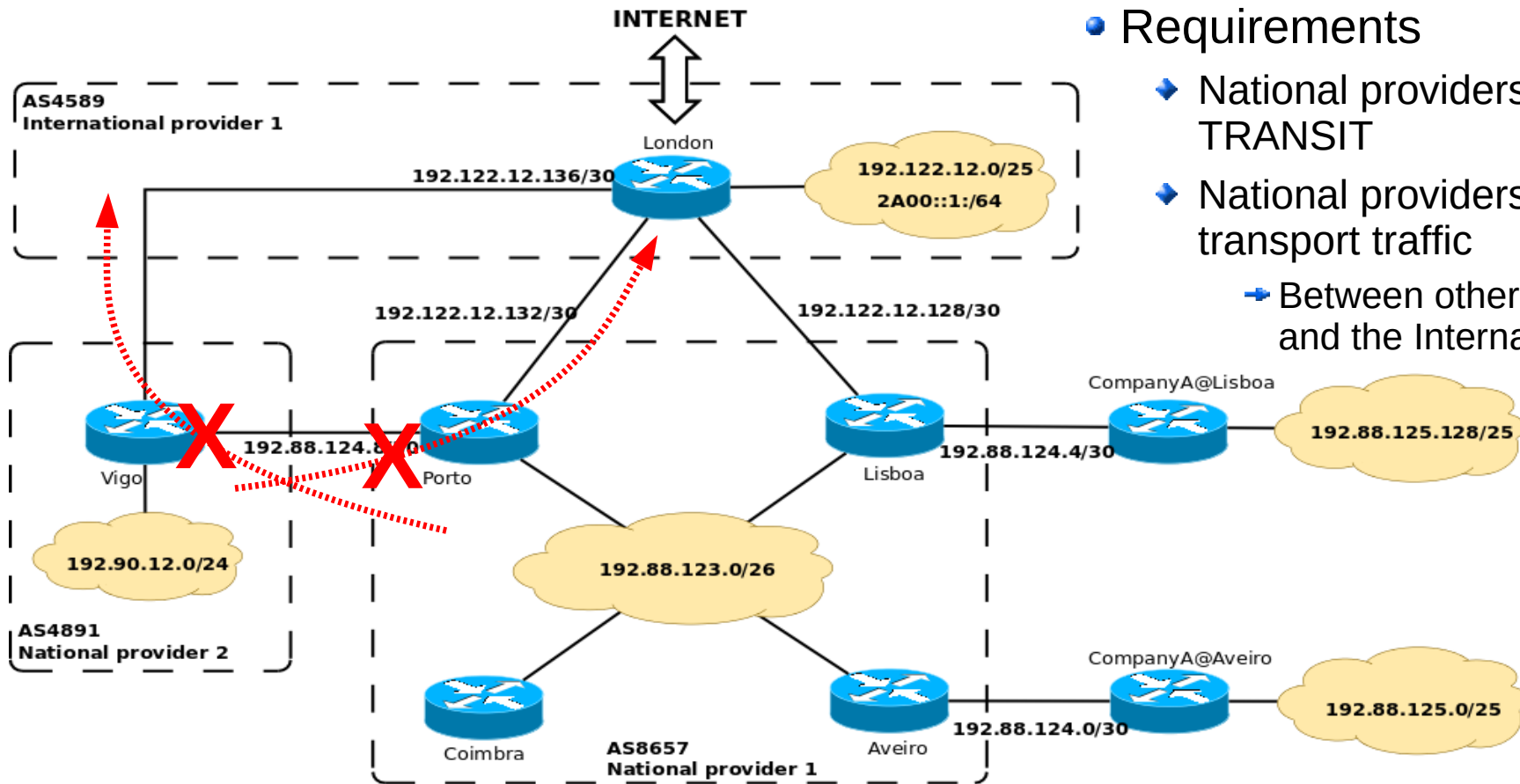

Requirements

- ◆ National providers are NON-TRANSIT
- ◆ National providers SHOULD NOT transport traffic
 - ➔ Between other national providers and the International provider

@Porto, @Lisboa

- ◆ Route filtering applied to all external BGP announcements
- ◆ Announce only internal routes/nets
 - ➔ Empty path “^\$”

@Vigo

- ◆ Route-map applied to all external BGP announcements
- ◆ Announce only internal routes/nets
 - ➔ Empty path “^\$”



BGP Case Studies

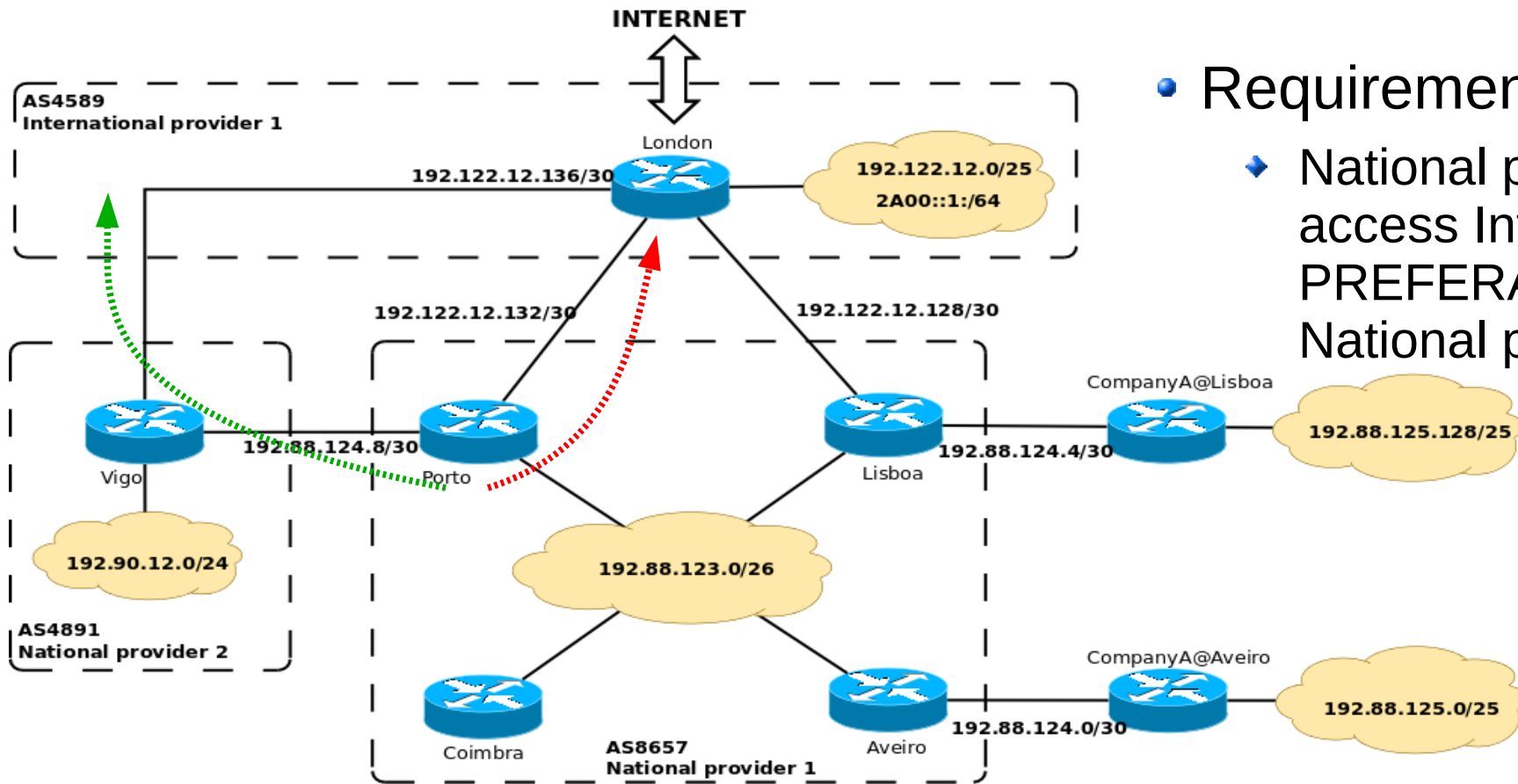

- Requirements

- ◆ National provider 1 should access Internet PREFERABLY using National provider 2

- @Porto, @Lisboa

- ◆ Route filtering applied to all BGP announcements received
- ◆ All routes received from neighbor AS4891 → **Local-preference 200**
- ◆ All routes received from other neighbors → **Local-preference 100**



BGP Case Studies

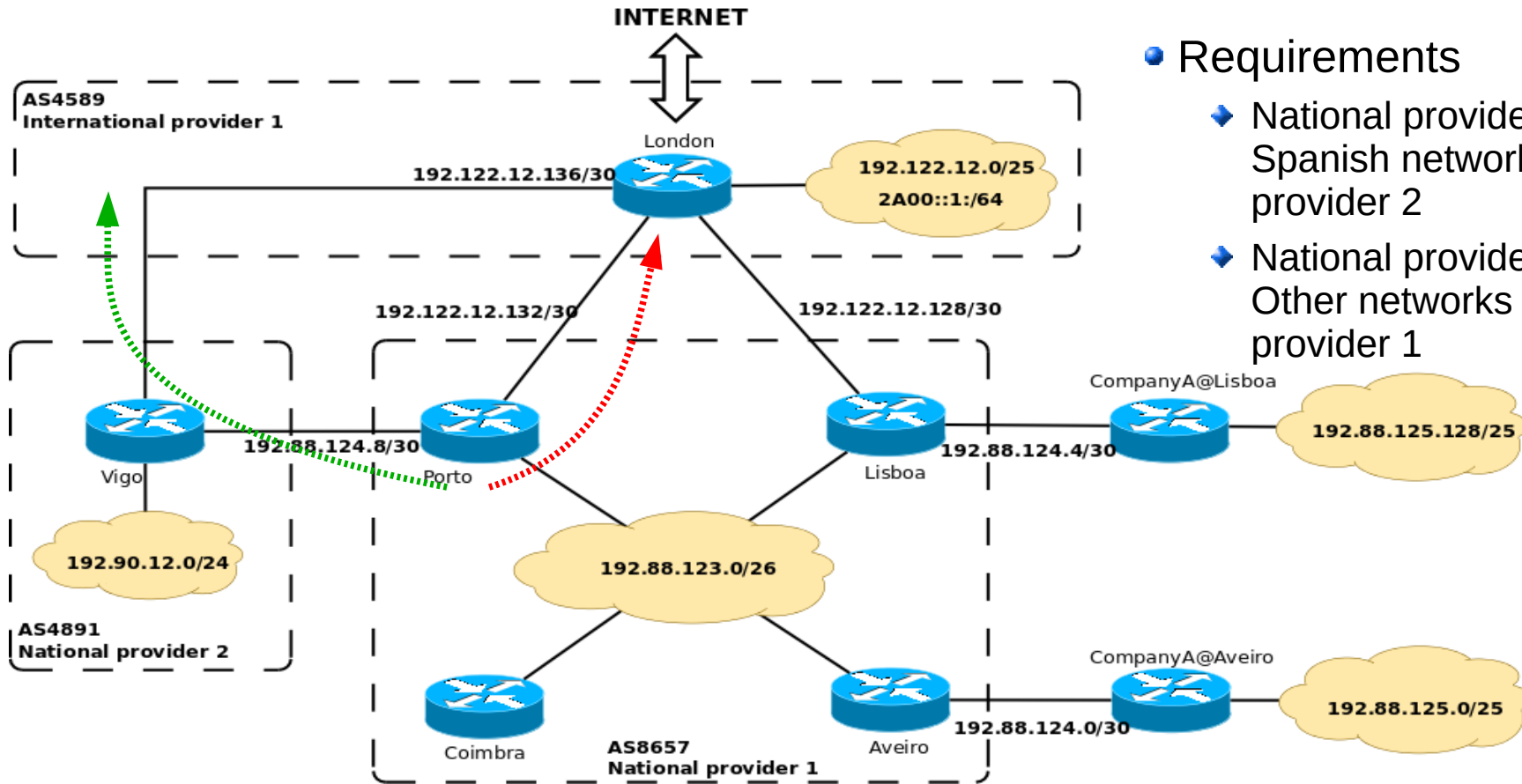

Requirements

- ◆ National provider 1 should access Spanish networks using National provider 2
- ◆ National provider 1 should access Other networks using International provider 1

@Porto, @Lisboa

- ◆ Route filtering applied to all BGP announcements received
 - E.g. known Spanish operators AS: 4891, 7654, 9876 and 3352
- ◆ If Path starts (from right to left) with "4891\$ or 7654\$ or 9876\$ or 3352\$" and ends in "^4891" → **Local-preference 200**
- ◆ If Path does not start with "4891\$ or 7654\$ or 9876\$ or 3352\$" and ends in "^4891" → **Local-preference 50**
- ◆ Assuming default Local-preference 100.



BGP Case Studies

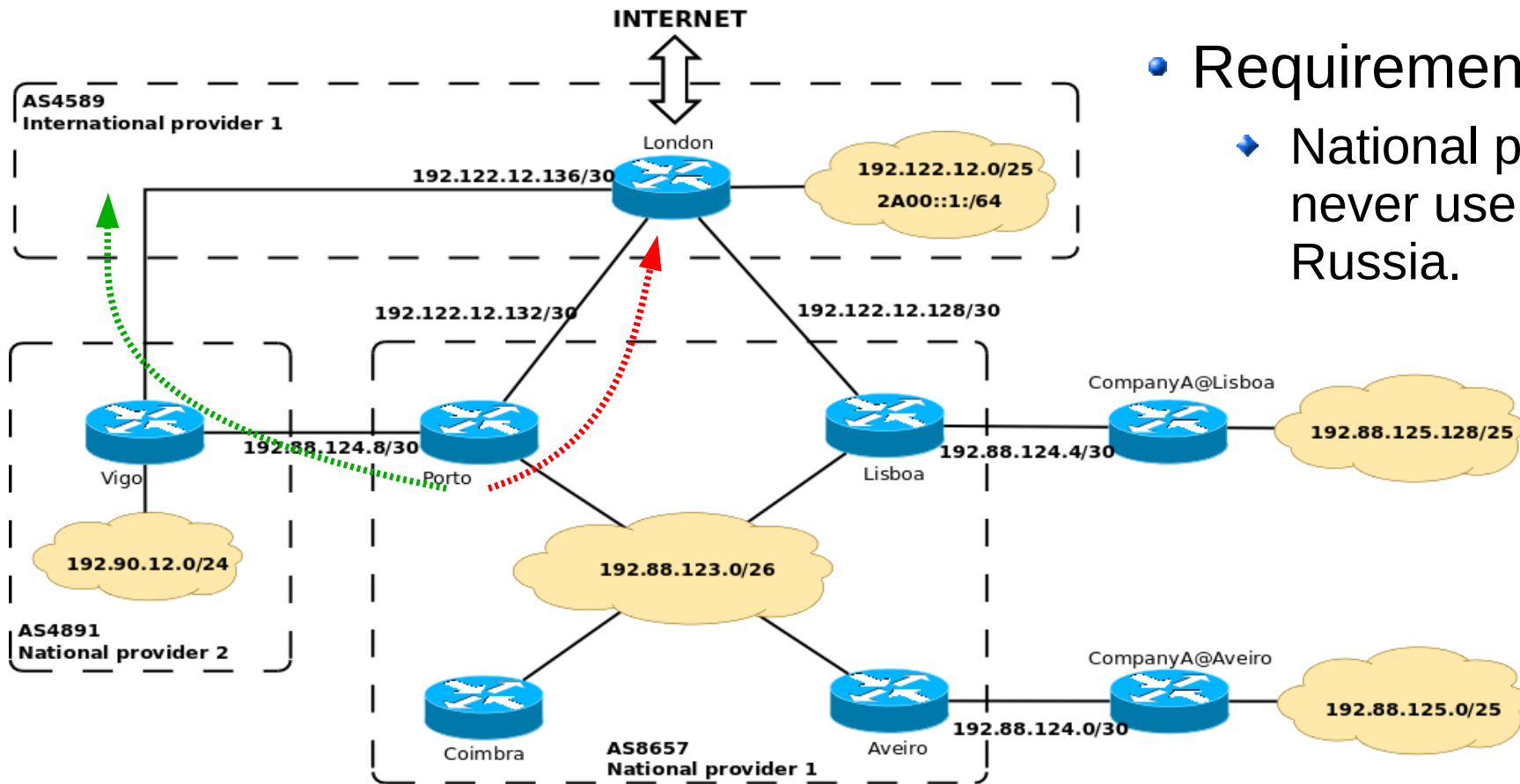

- Requirements
 - ◆ National provider 1 should never use paths via Russia.

- @Porto, @Lisboa

- ◆ Route filtering applied to all BGP announcements received
 - E.g. known Russian operators AS: 12714, 12730, 2766 and 2848.
- ◆ If Path contains “12714 or 12730 or 2766 or 2848” → **Delete the announcement**

