



universidade de aveiro
theoria poiesis praxis

Ports, Services, Transport

Redes de Comunicações 1

Licenciatura em Engenharia de Comunicações e
Informática

DETI-UA, 2021/2022

Transport services and protocols

- ❑ provide *logical communication* between application processes running on different hosts
- ❑ transport protocols run in end systems
 - sender side: breaks application messages into *segments*, passes to network layer
 - receiver side: reassembles segments into messages, passes to application layer
- ❑ two transport protocols available to applications:
 - TCP and UDP

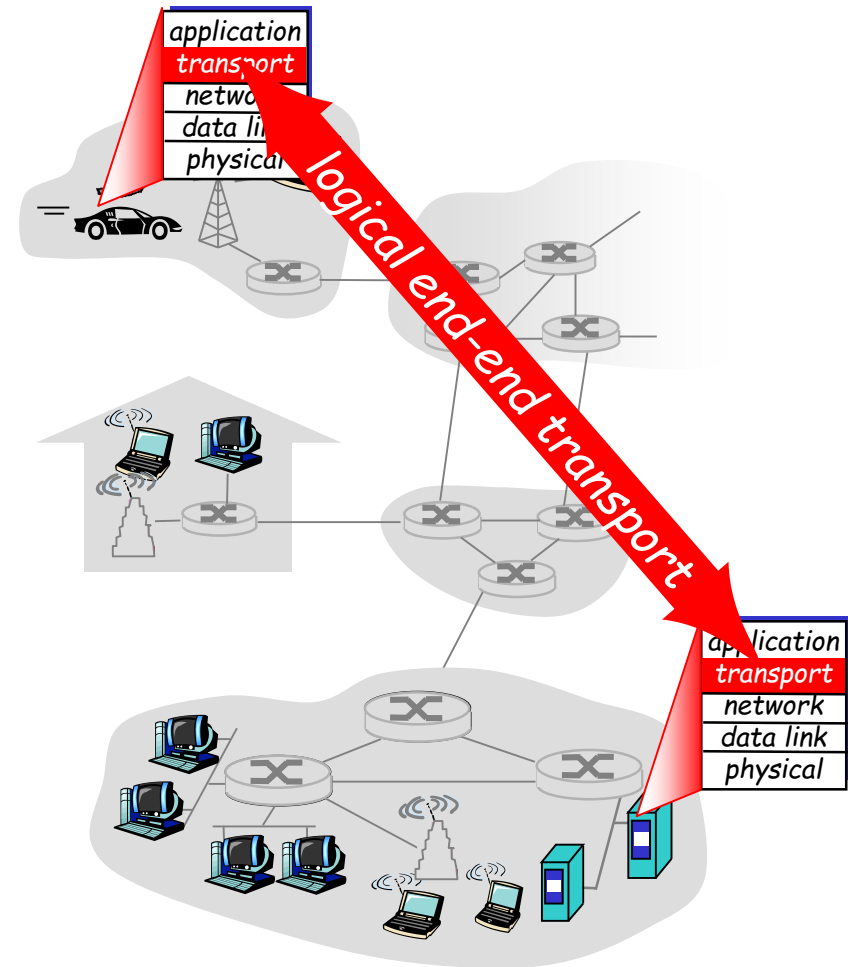

Internet transport-layer protocols

- ❑ reliable, in-order delivery: TCP
 - connection setup
 - flow control
 - congestion control
- ❑ unreliable, unordered delivery: UDP
 - extension of "best-effort" IP
- ❑ services not available:
 - delay guarantees
 - bandwidth guarantees

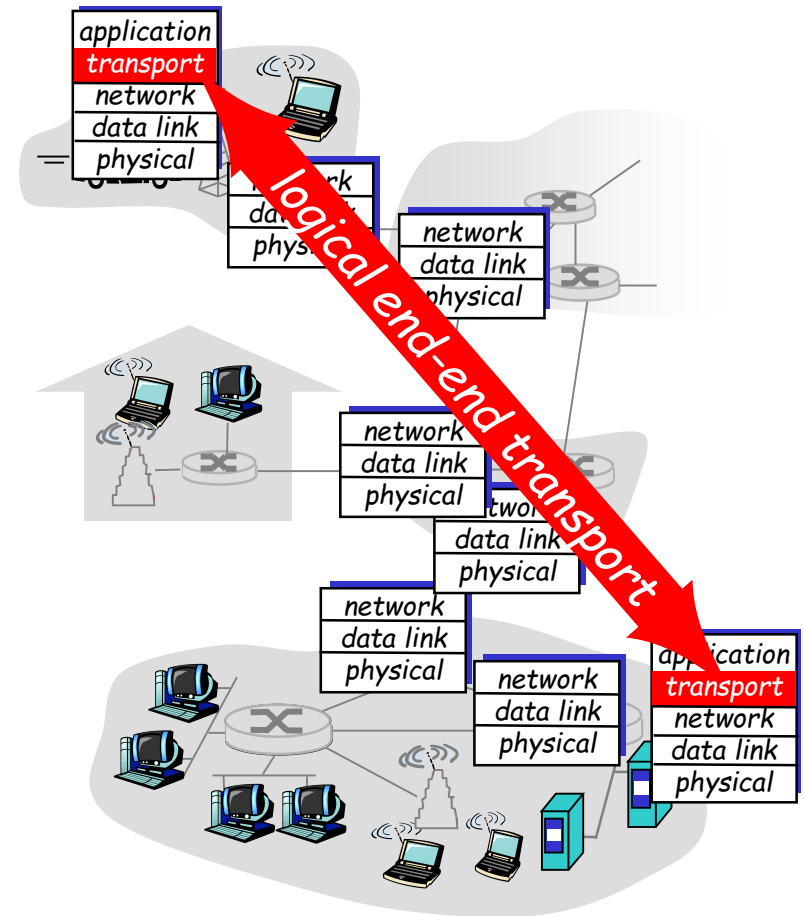

Reference Model

Upper		FTP	Telnet	HTTP
Transport		UDP	TCP	
Internet		IP		
Link		Ethernet	packet radio	ponto-a-ponto
Physical				

MULTIPLEXING AND DEMULTIPLEXING

Multiplexing/demultiplexing

Demultiplexing at receiver host:

delivering received segments to correct socket

Multiplexing at sender host:

gathering data from multiple sockets, enveloping data with header (later used for demultiplexing)

■ = socket ○ = process

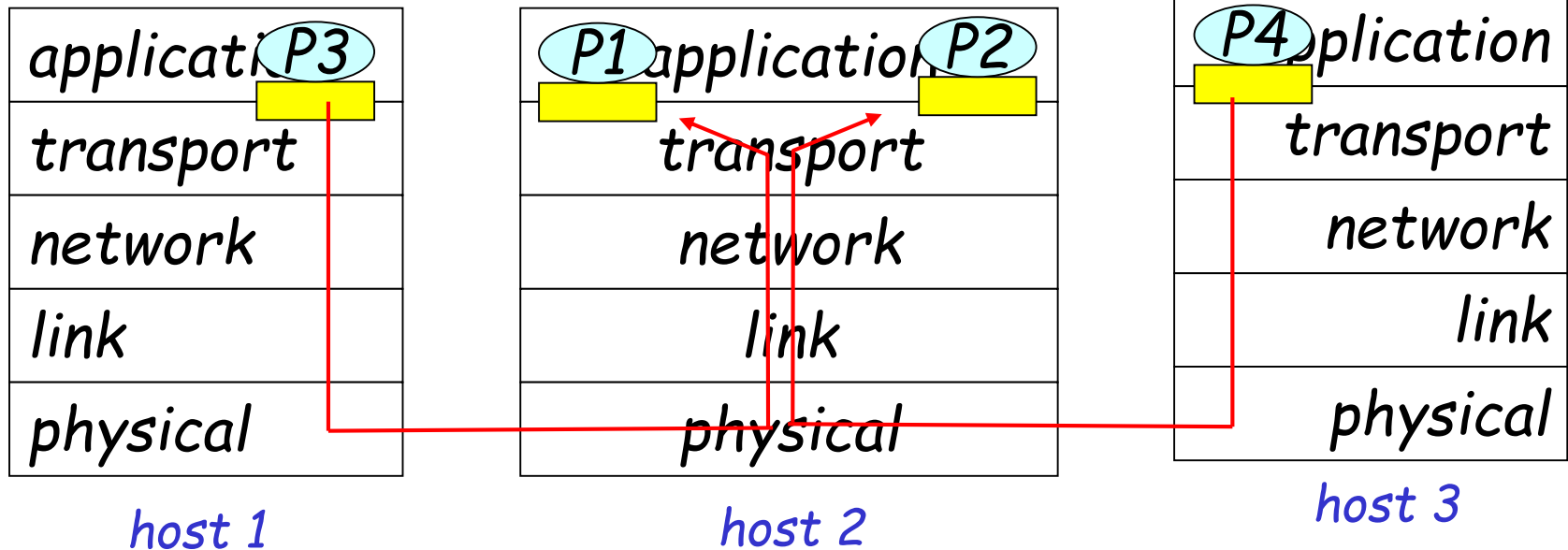

How demultiplexing works

- **host receives IP datagrams**
 - each datagram has source IP address, destination IP address
 - each datagram carries 1 transport-layer segment
 - each segment has source, destination port number
- **host uses IP addresses and port numbers to direct segment to appropriate socket**

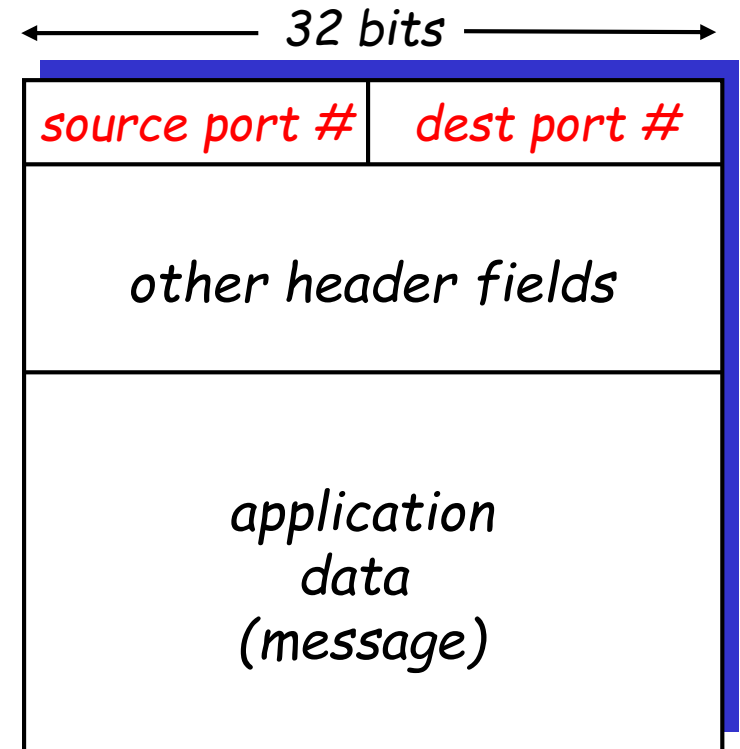

TCP/UDP segment format

Connectionless demultiplexing

- ❑ Create sockets with port numbers:

```
DatagramSocket mySocket1 = new  
    DatagramSocket(12534);
```

```
DatagramSocket mySocket2 = new  
    DatagramSocket(12535);
```

- ❑ UDP socket identified by 2-tuple:

(destination IP address, destination port number)

- ❑ When host receives UDP segment:
 - checks destination port number in segment
 - directs UDP segment to socket with that port number
- ❑ IP datagrams with different source IP addresses and/or source port numbers are directed to the same socket

Connectionless demux (cont)

```
DatagramSocket serverSocket = new DatagramSocket(6428);
```

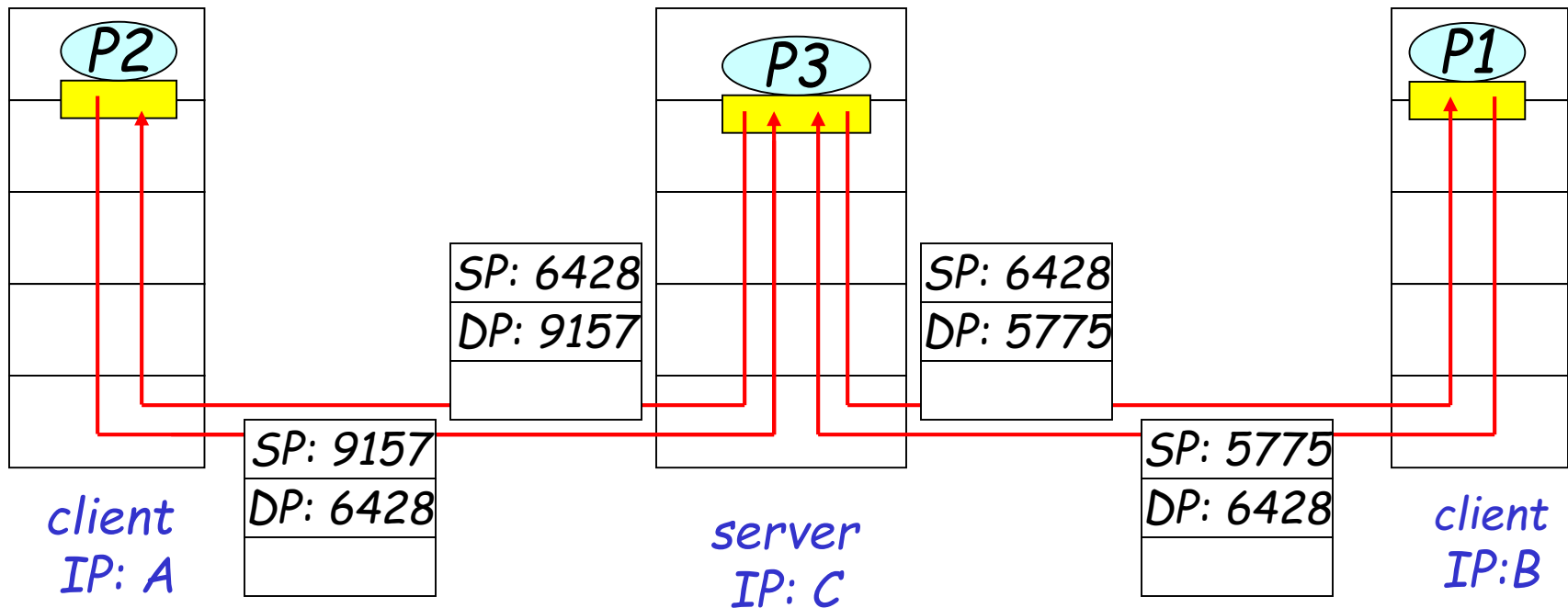

SP provides "return address"

Connection-oriented demux

- ❑ TCP socket identified by 4-tuple:
 - source IP address
 - source port number
 - destination IP address
 - destination port number
- ❑ receiver host uses all four values to direct segment to appropriate socket
- ❑ Server host may support many simultaneous TCP sockets:
 - each socket identified by its own 4-tuple
- ❑ For example, Web servers have different sockets for each connecting client

Connection-oriented demux (cont)

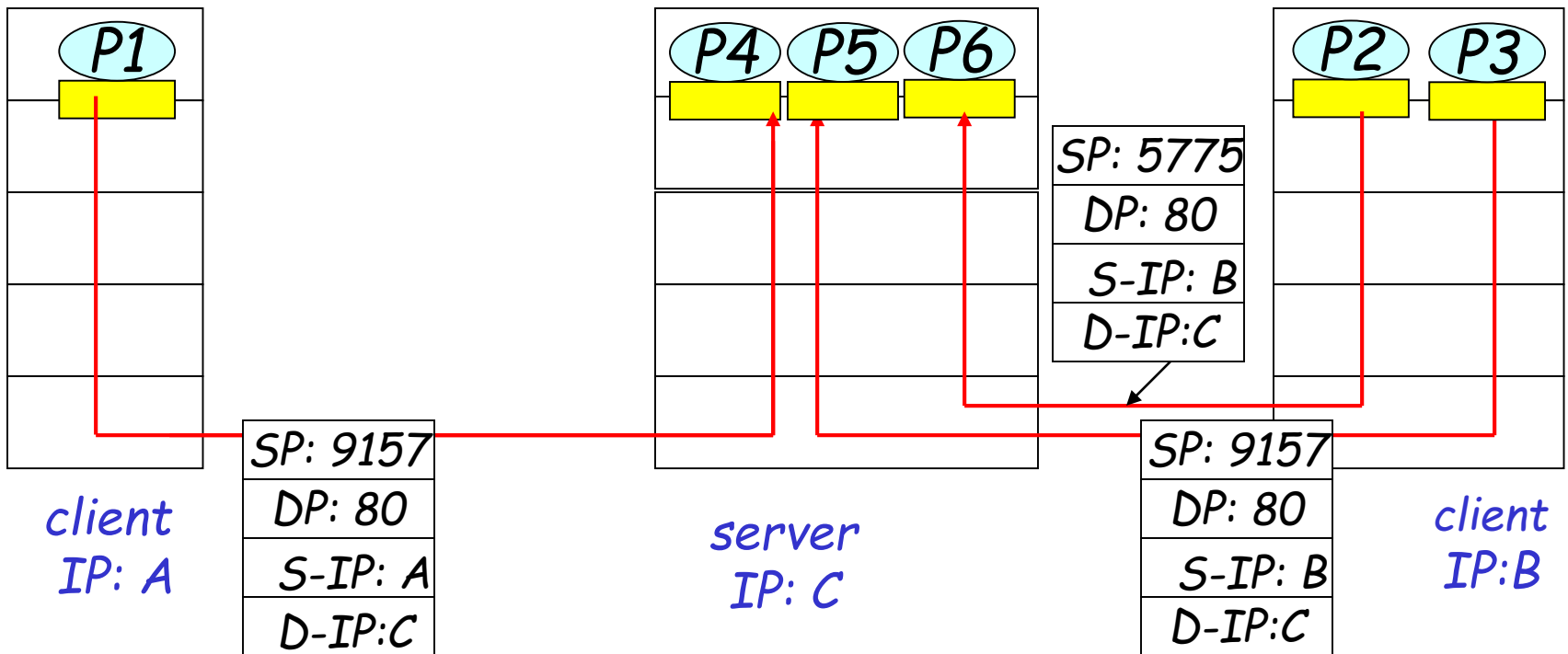

Connection-oriented demux: Threaded Web Server

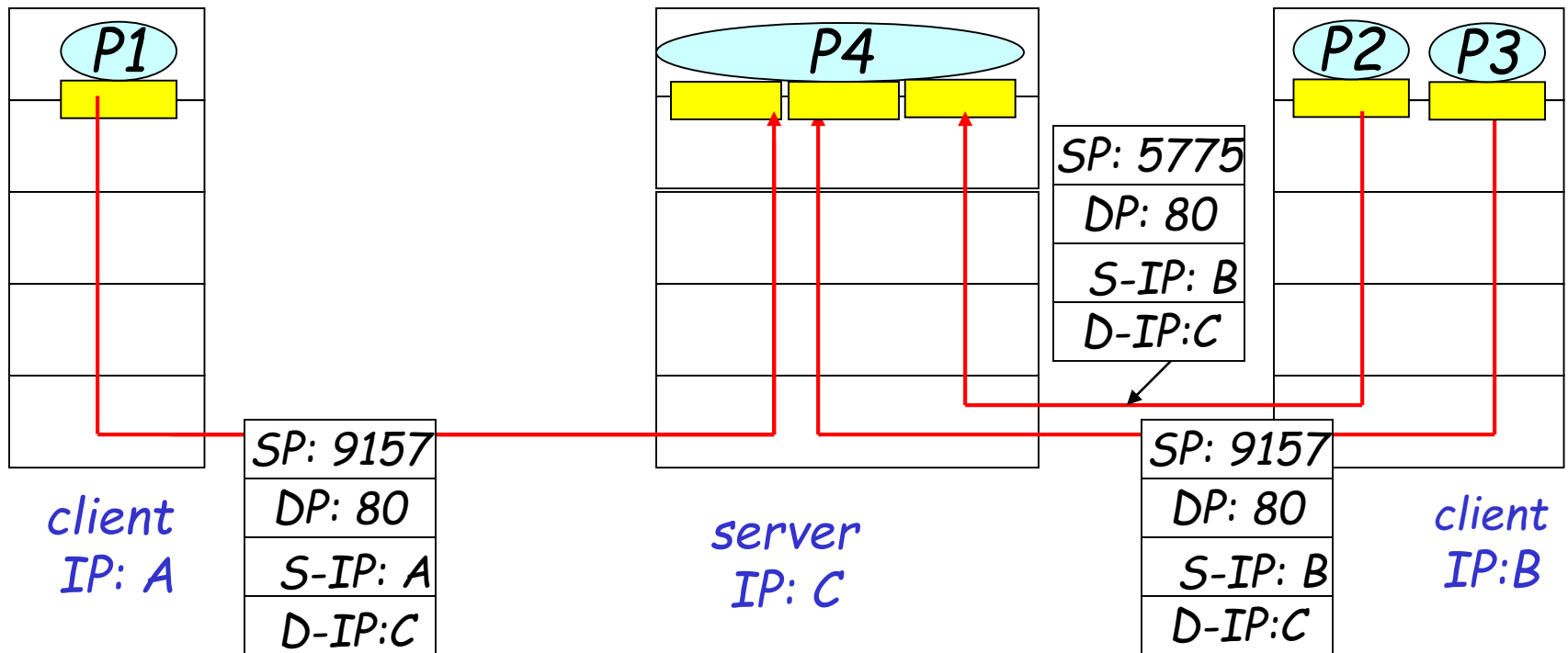

Allocated Ports

Decimal	Palavra Chave	Protocolo	Descrição
20	FTP-DATA	TCP	File Transfer Protocol (dados)
21	FTP-CONTROL	TCP	File Transfer Protocol (controle)
23	TELNET	TCP	Terminal Connection
25	SMTP	TCP	Simple Mail Transport Protocol
67,68	BOOTP	UDP	Bootstrap Protocol
53	DNS	UDP/TCP	Domain Name System
69	TFTP	UDP	Trivial File Transfer Protocol
80	HTTP	TCP	Hypertext Transfer Protocol

UDP

User Datagram Protocol

- ❑ Provides a seamless service to transport data with the performance characteristics offered by IP
- ❑ Allows the exchange of data between applications, through a header and port identifier
- ❑ Allows the sending of data for multiple destinations (multi-point communications)

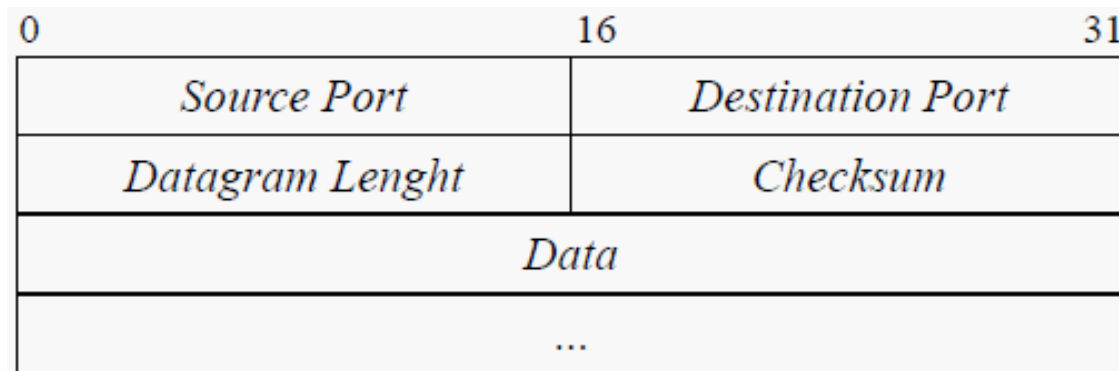

- ❑ *Checksum*: datagrama UDP + pseudoheader IP (ID protocol IP, sender IP address, destination IP address, length IP datagram)
 - ❖ Verify if the message was sent between the correct endpoints

TCP

TCP: Overview

RFCs: 793, 1122, 1323, 2018, 2581

- ❑ **point-to-point:**
 - one sender, one receiver
- ❑ **reliable, in-order byte stream:**
 - no "message boundaries"
- ❑ **pipelined:**
 - TCP congestion and flow control set window size
- ❑ **send & receive buffers**
- ❑ **full duplex data:**
 - bi-directional data flow in same connection
 - MSS: Maximum Segment Size; in general, MTU of attached link - (IP + TCP header lengths)
- ❑ **connection-oriented:**
 - handshaking (exchange of control messages): initiates sender and receiver state before data exchange
- ❑ **flow controlled:**
 - sender will not overwhelm receiver

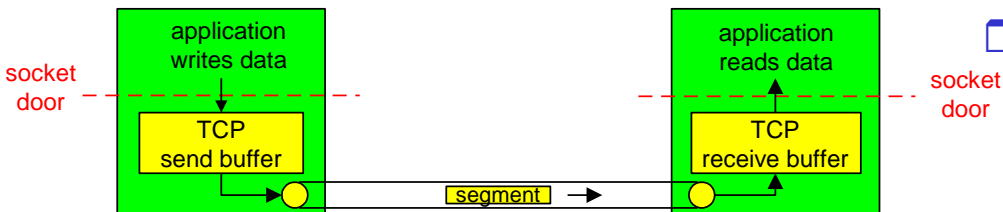

TCP segment structure

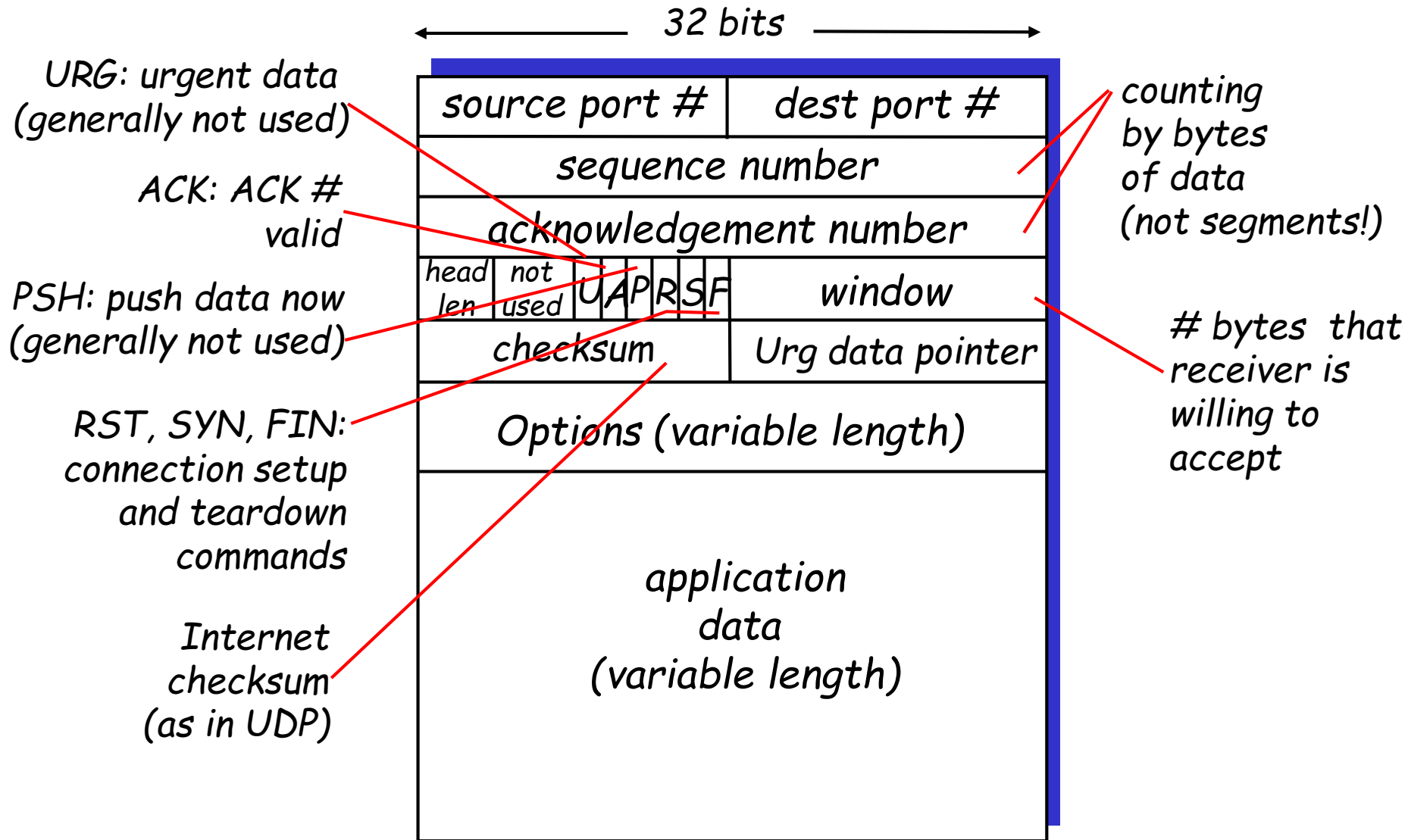

TCP seq. numbers and ACKs

Seq. number:

- byte stream "number" of first byte in segment's data

ACKs:

- seq. number of next byte expected from other side
- cumulative ACK

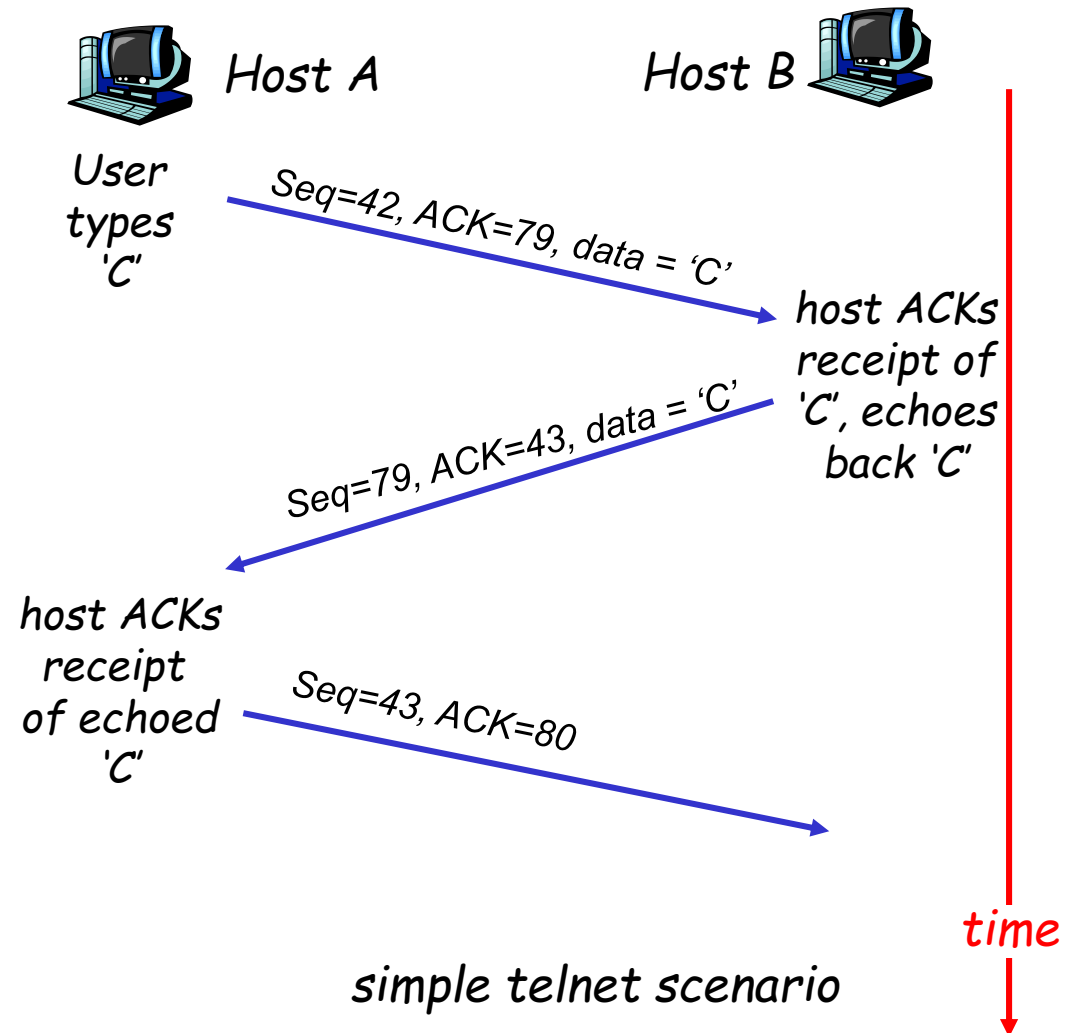

Establishment of a TCP Session

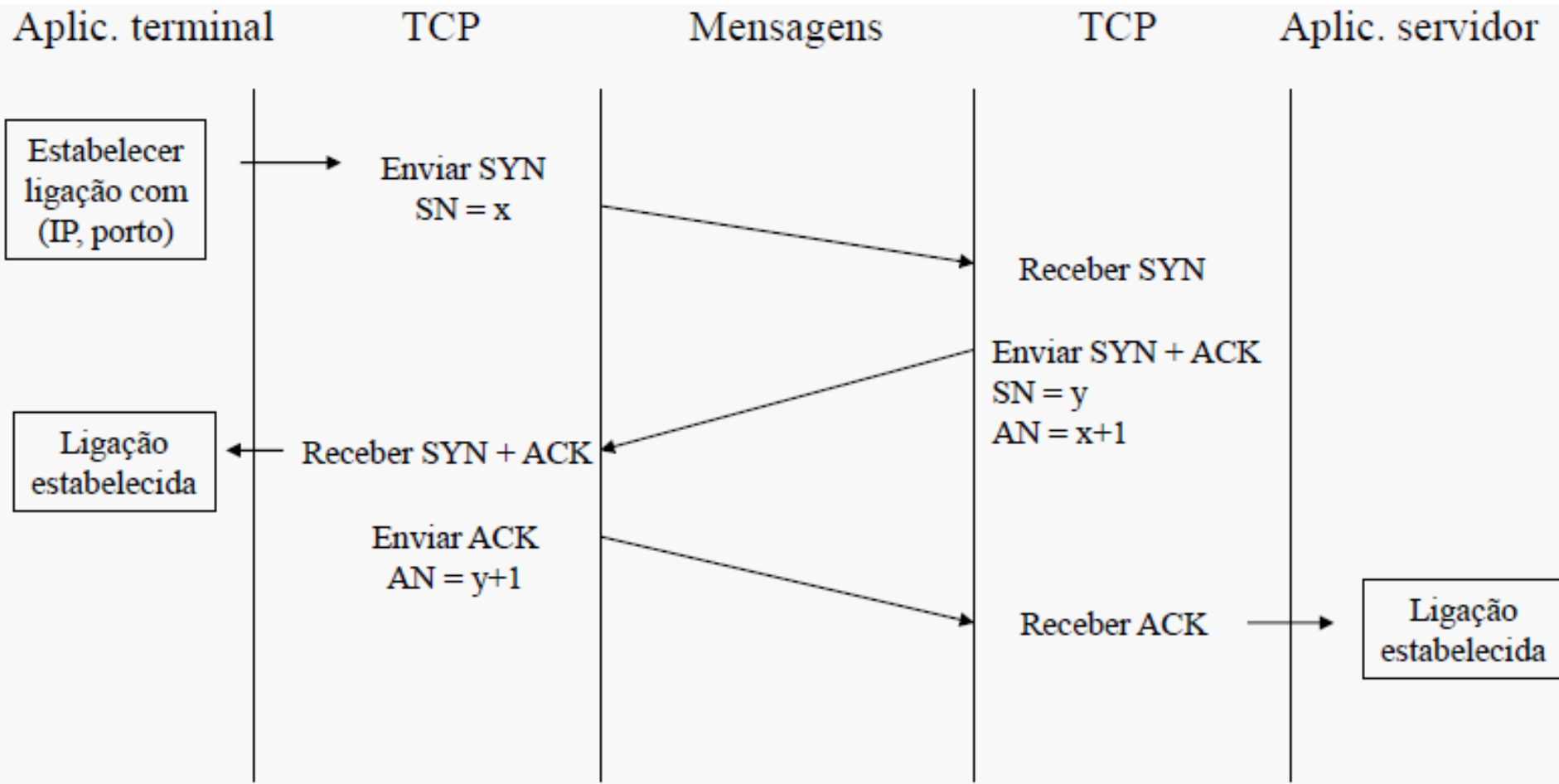

Termination of a TCP Session

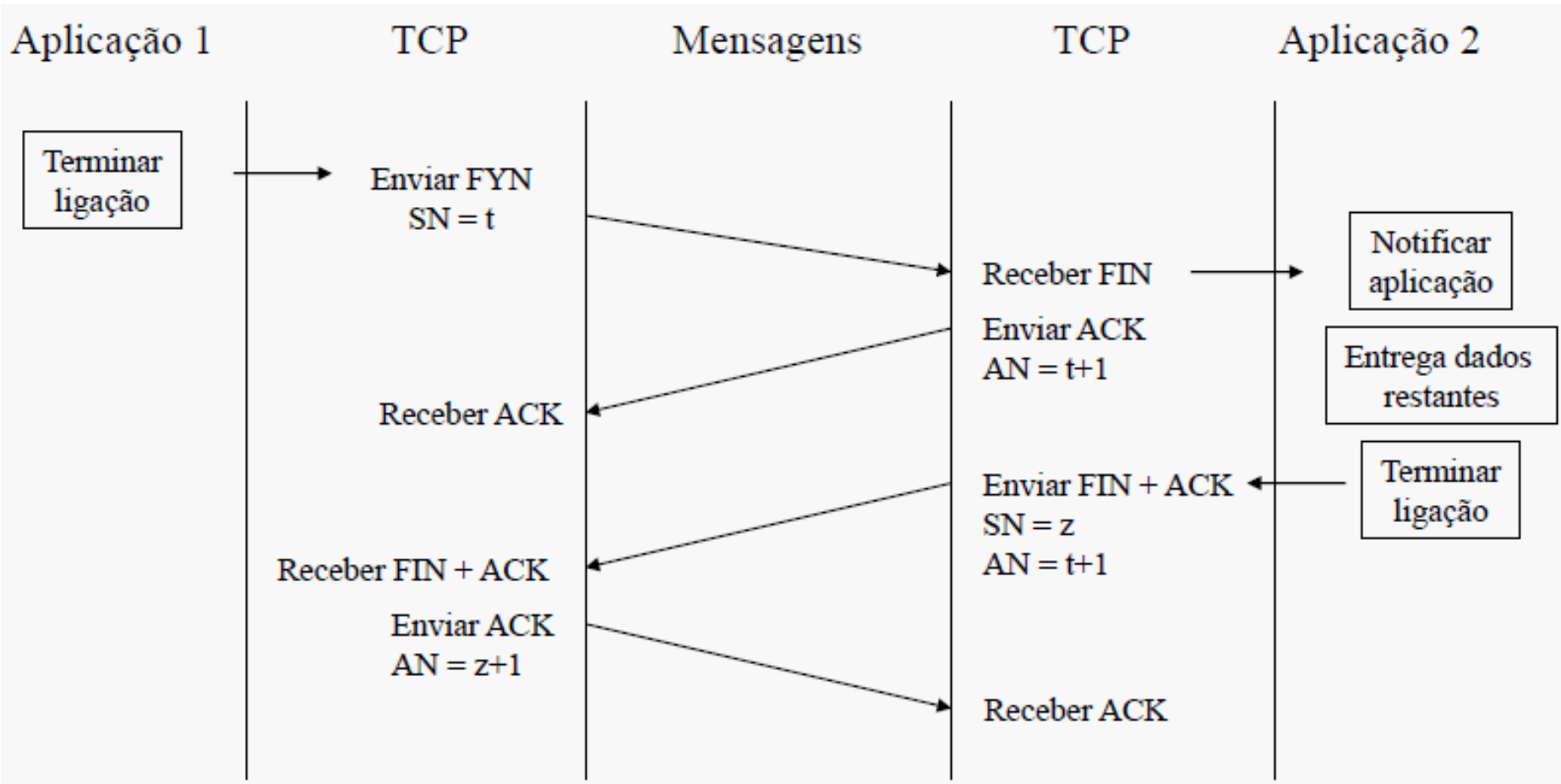

Flow Control

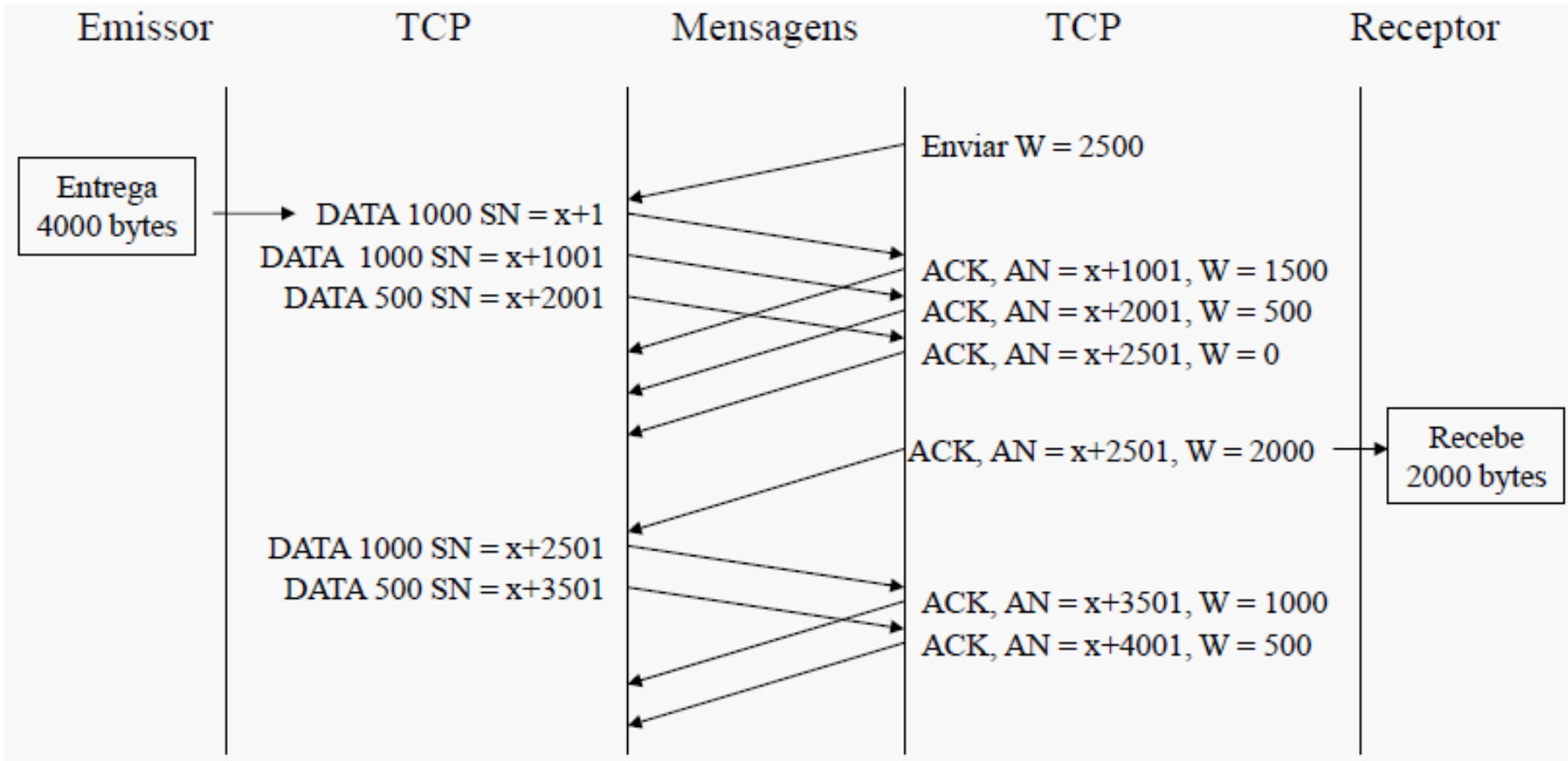

TCP Header Fields

- ❑ *Sequence Number* : data already sent
- ❑ *Acknowledge Number* : data already received
- ❑ *Window* : receiver informs sender of how many octets is ready to receive
- ❑ *Sequence Number* refers to transmission side, *Acknowledge Number* and *Window* refer to the opposite direction

Example (1)

- Consider a TCP connection from A to B. In both stations, TCP:
 - Considers a reception buffer of 2000 bytes
 - Segments information is packets with a maximum of 1000 bytes
 - Station A chooses an initial Sequence Number of 1515, and Station B chooses an initial Sequence Number of 502
 - Station A sends a block of 5300 bytes and station B does not send data.
- Draw the timing diagram of TCP segments exchanged, including establishment and termination.

Example (2)

- Consider a TCP connection between 2 stations A and B. They exchanged the following TCP segments. Which station is the client? What is the size (in bytes) of the data field in each segment, and the overall size of the data?

	Origem	Destino	SN	AN	W	Flags
1º segmento:	A	B	255	0	10000	SYN,
2º segmento:	B	A	4329	256	20000	SYN, ACK
3º segmento:	A	B	256	4330	10000	ACK
4º segmento:	B	A	4330	256	20000	ACK
5º segmento:	A	B	256	5000	10000	ACK
6º segmento:	B	A	5000	276	20000	FIN , ACK
7º segmento:	A	B	276	5201	10000	ACK
8º segmento:	A	B	276	5201	10000	FIN , ACK
9º segmento:	B	A	5201	277	1200	ACK

How to know that a packet shall be retransmitted?

After a specific time, the packet needs to be considered lost

Long time always?

Small time always?

Should depend on the delays in the network/path

Should depend on the round trip time

TCP Round Trip Time (RTT) and Timeout

Question: how to set TCP timeout value?

- ❑ larger than RTT
 - but RTT varies
- ❑ too short: premature timeout
 - unnecessary retransmissions
- ❑ too long: slow reaction to segment loss

Question: how to estimate RTT?

- ❑ **SampleRTT**: measured time from segment transmission until ACK receipt
 - ignore retransmissions
- ❑ **SampleRTT** will vary, want estimated RTT "smoother"
 - to average several recent measurements, and not used just the last **SampleRTT**

TCP Round Trip Time (RTT) and Timeout

$$\mathit{EstimatedRTT} = (1 - \alpha) * \mathit{EstimatedRTT} + \alpha * \mathit{SampleRTT}$$

- Exponential weighted moving average
- Influence of past sample decreases exponentially fast
- Typical value: $\alpha = 0.125$

EstimatedRTT after the K^{th} ACK
SampleRTT of K^{th} ACK

Example RTT estimation:

RTT: gaia.cs.umass.edu to fantasia.eurecom.fr

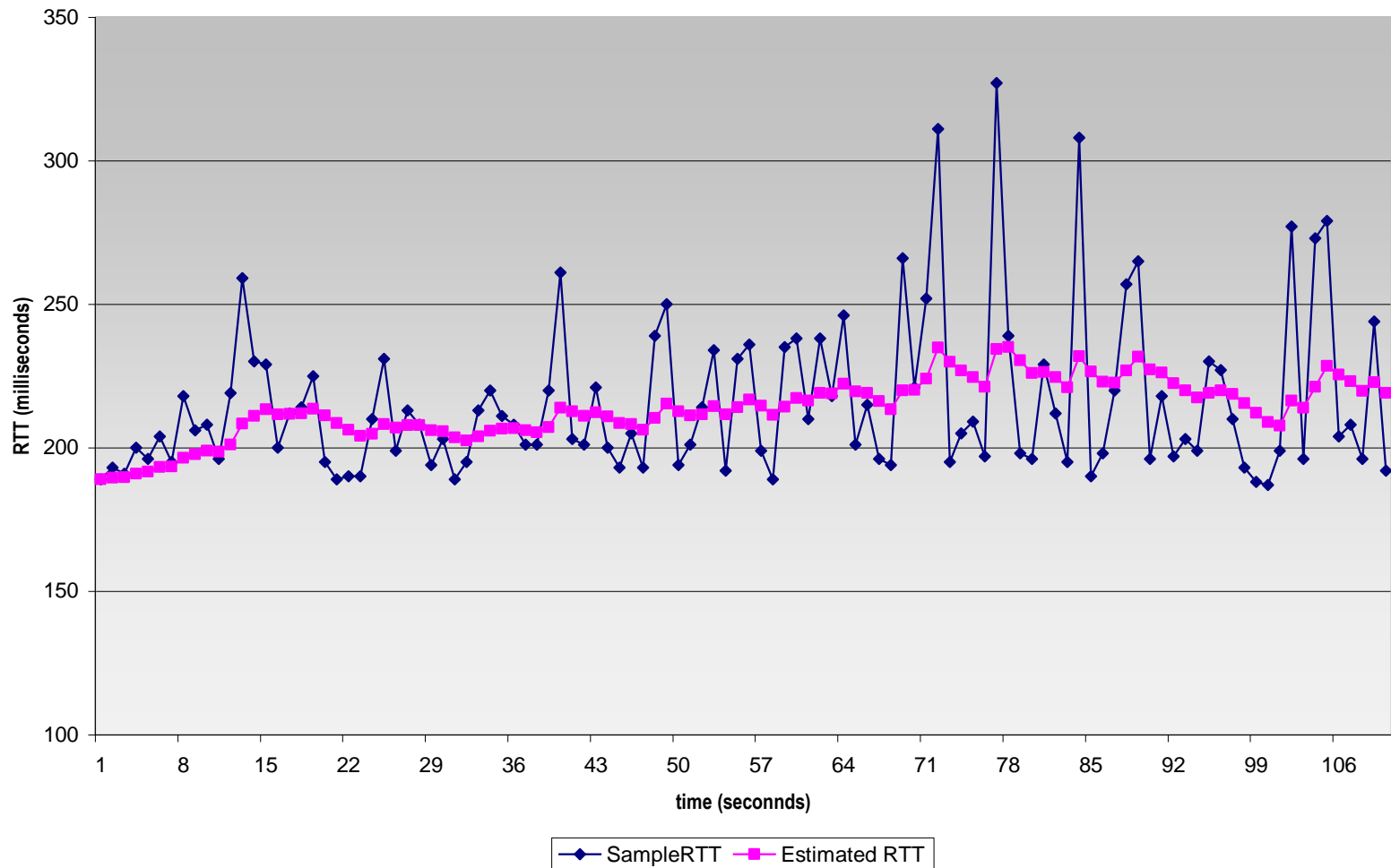

TCP Round Trip Time and Timeout

Setting the timeout

- EstimatedRTT plus "safety margin"
 - large variation in EstimatedRTT → larger safety margin
- first estimate of how much SampleRTT deviates from EstimatedRTT:

$$\text{DevRTT} = (1-\beta) * \text{DevRTT} + \beta * |\text{SampleRTT} - \text{EstimatedRTT}|$$

(typically, $\beta = 0.25$)

Then set timeout interval:

$$\text{TimeoutInterval} = \text{EstimatedRTT} + 4 * \text{DevRTT}$$

IETF RFC 793 proposes $1.3 < \beta < 2.0$

TCP Retransmissions

TCP Slow Start

- When connection begins, increase rate exponentially until first loss event:
 - double CongWin every RTT
 - done by incrementing CongWin for every ACK received
- Summary: initial rate is slow but ramps up exponentially fast

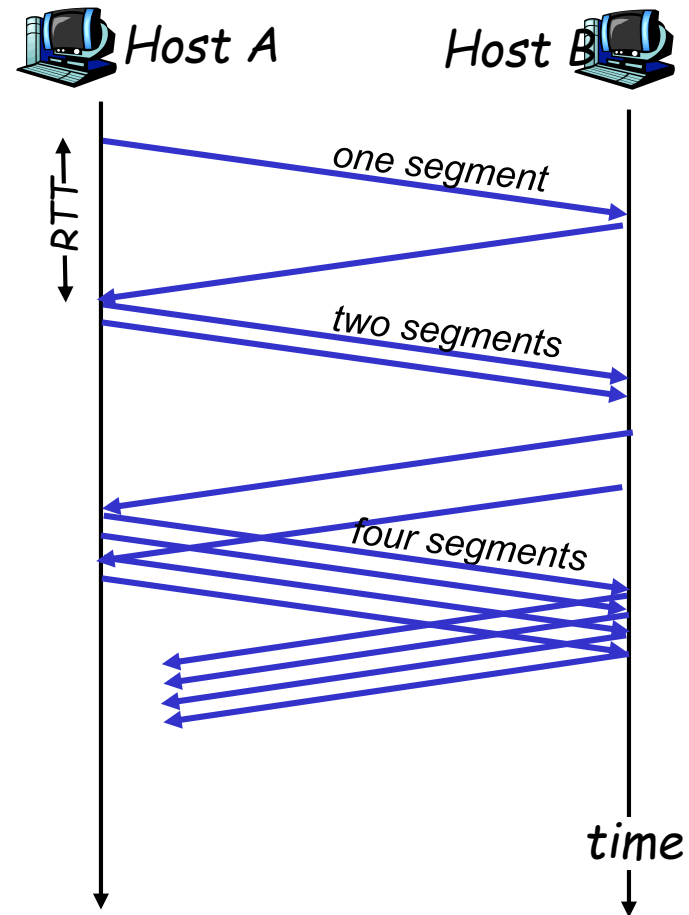

TCP Slow Start

- When connection begins, $\text{CongWin} = 1$ packet
- Each time an ACK is received, CongWin is incremented by 1 segment of maximum size
- When connection begins, increase rate exponentially fast until first loss event

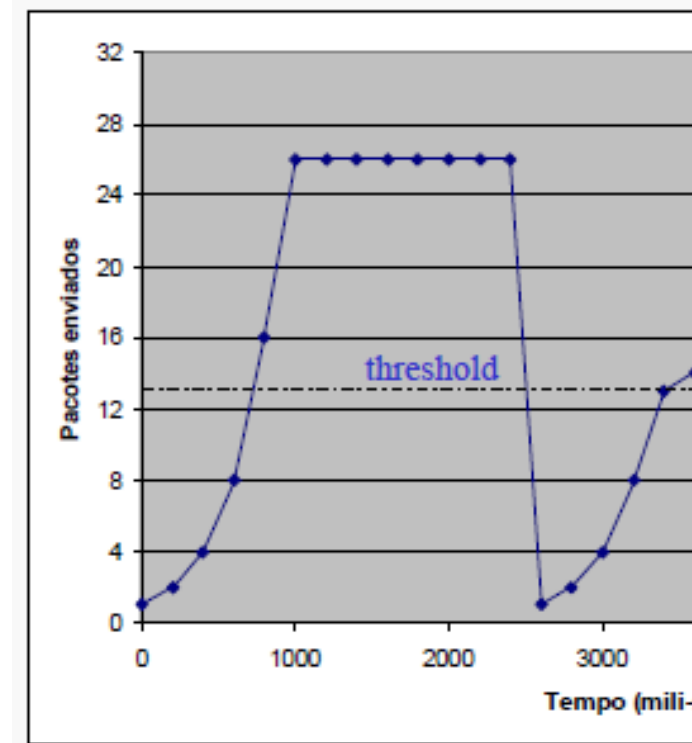

TCP Congestion avoidance

- When the rate is larger, increase the window more carefully
 - Congestion avoidance
 - Window increases linearly to avoid losses

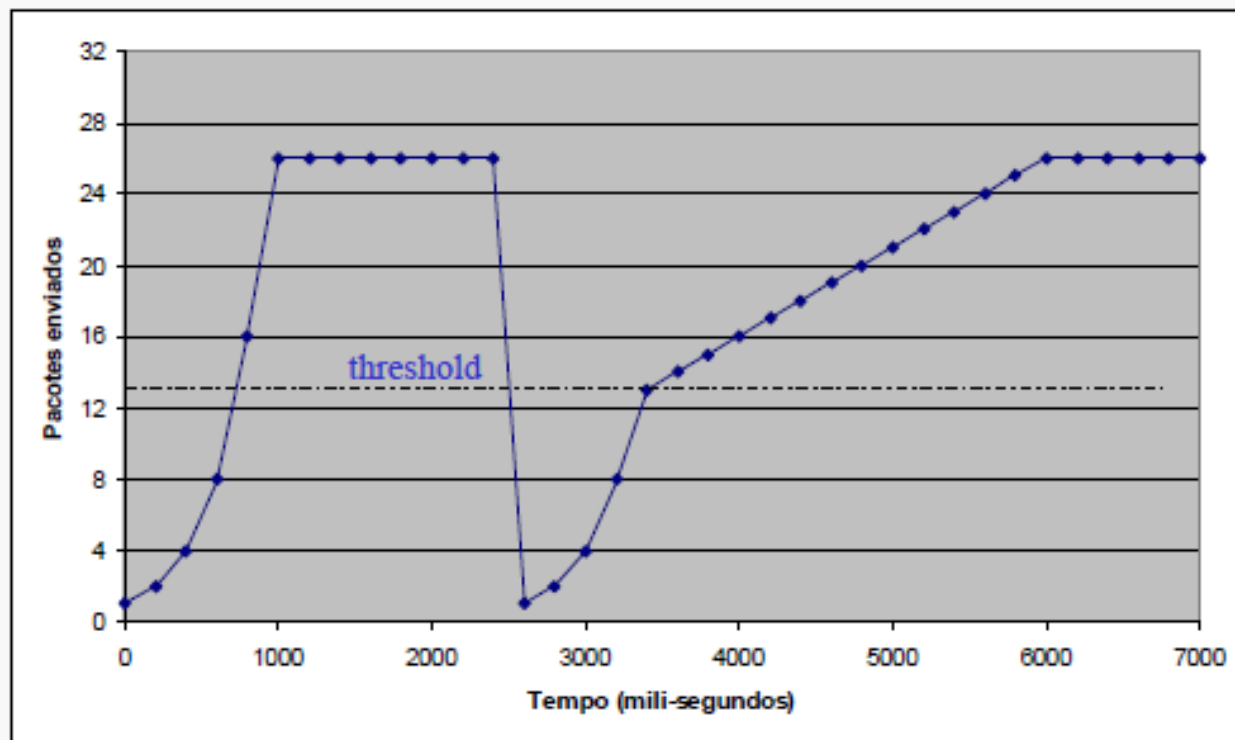

Fast Retransmission mechanism

- Detect lost segments via duplicate ACKs
 - Sender often sends many segments back-to-back
 - If segment is lost, there will likely be many duplicate ACKs.
- If sender receives 3 more ACKs for the same data, it supposes that segment after ACKed data was lost:
 - fast retransmission mechanism: when 3 duplicate ACKs are received, resend segment before timer expires

Duplicate ACKs before timeout: network is not too congested!

Duplicate ACKs and fast retransmission

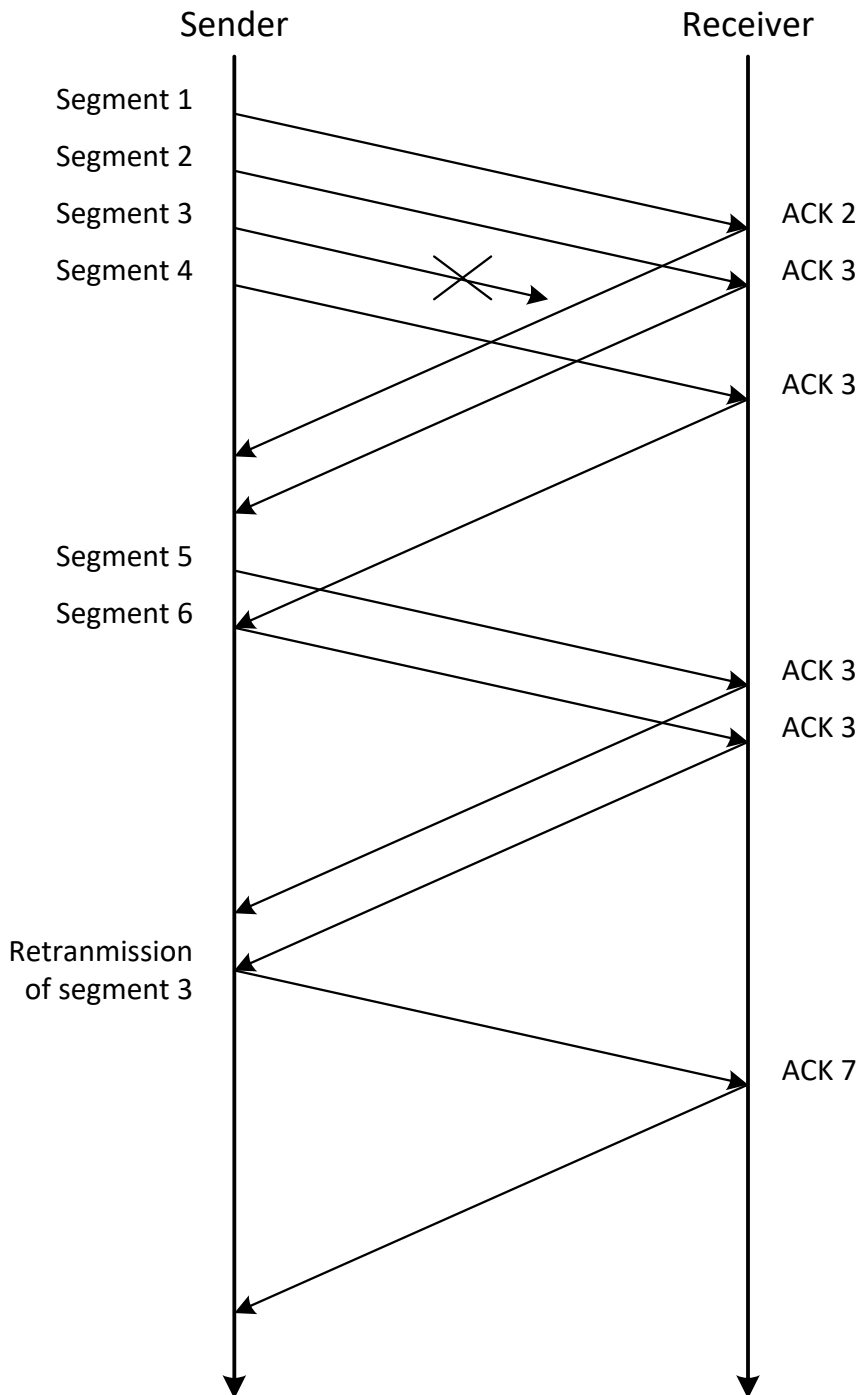

- Duplicate ACKs
 - ❖ Sender receives 3 duplicate ACKs of segment 3
- Fast retransmission
 - ❖ Sender retransmits segment 3 before Timeout of segment 3 expires

Refinement: inferring loss

- ❑ After 3 dup ACKs:
 - CongWin is cut in half
 - window then grows linearly
- ❑ But after timeout event:
 - CongWin instead set to 1 MSS;
 - window then grows exponentially
 - to a threshold, then grows linearly

Philosophy:

- ❑ *3 dup ACKs indicates network capable of delivering some segments*
- ❑ *timeout indicates a "more alarming" congestion scenario*

TCP Tahoe versus TCP Reno

TCP Tahoe:

- ❑ Congestion detection based only on Timeouts
- ❑ Slow start at beginning and when timeout occurs

TCP Reno

- ❑ Congestion detection based on Timeouts and 3 duplicated ACKs
- ❑ When timeout occurs
 - ❖ TCP Tahoe
- ❑ When 3 duplicated ACKs
 - ❖ Fast retransmission
 - ❖ Fast recovery

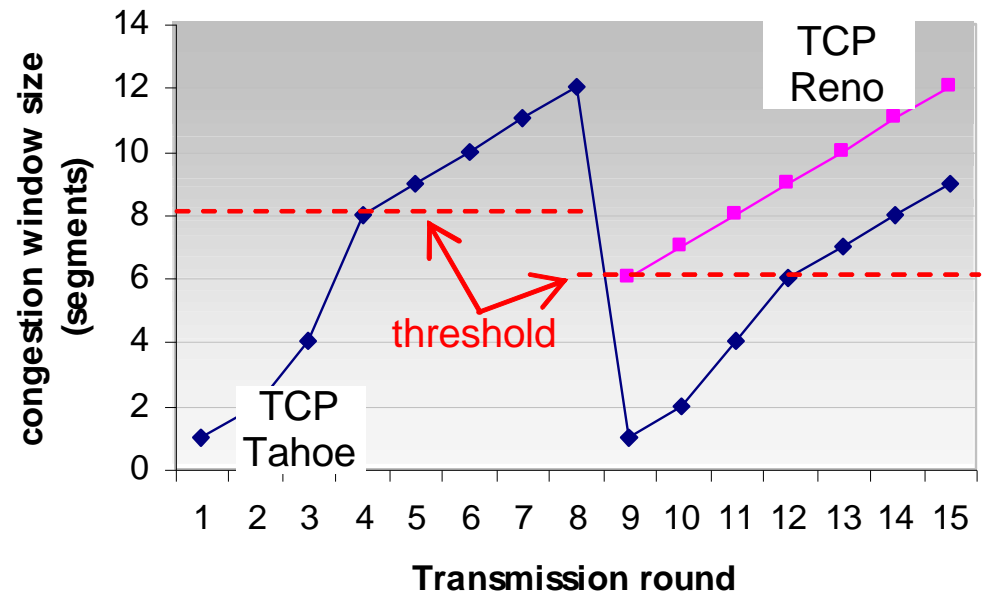

UDP and TCP coexistence

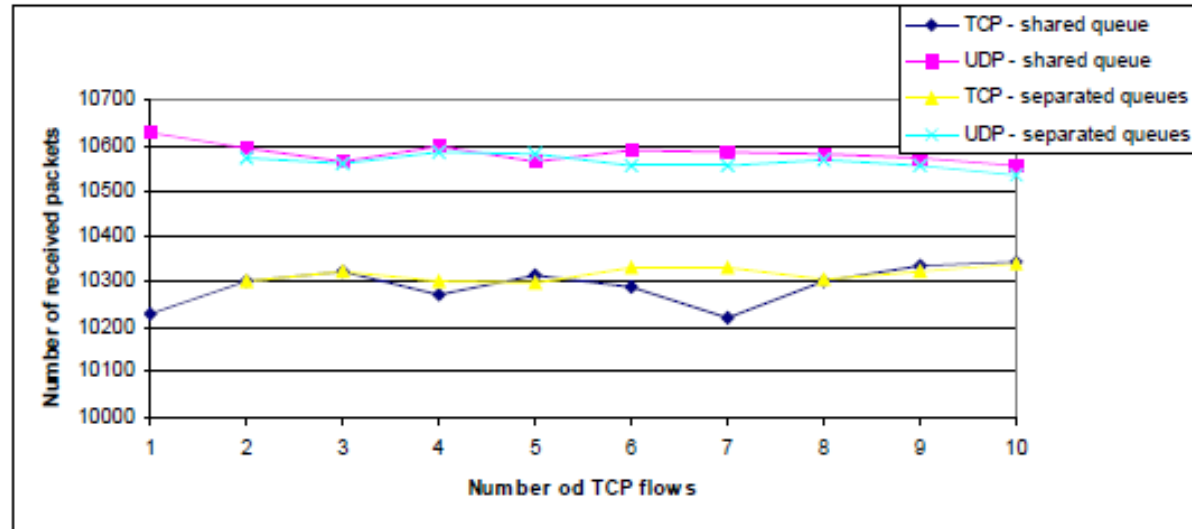
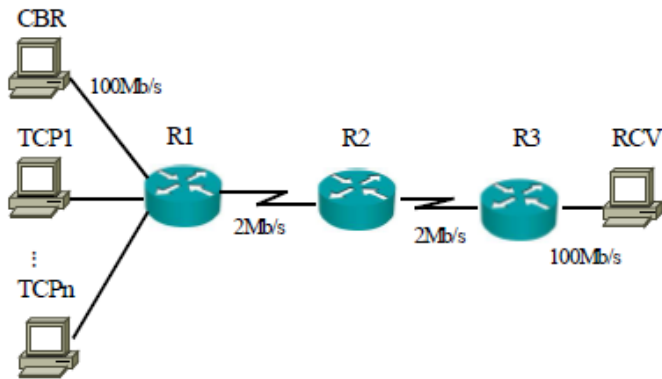
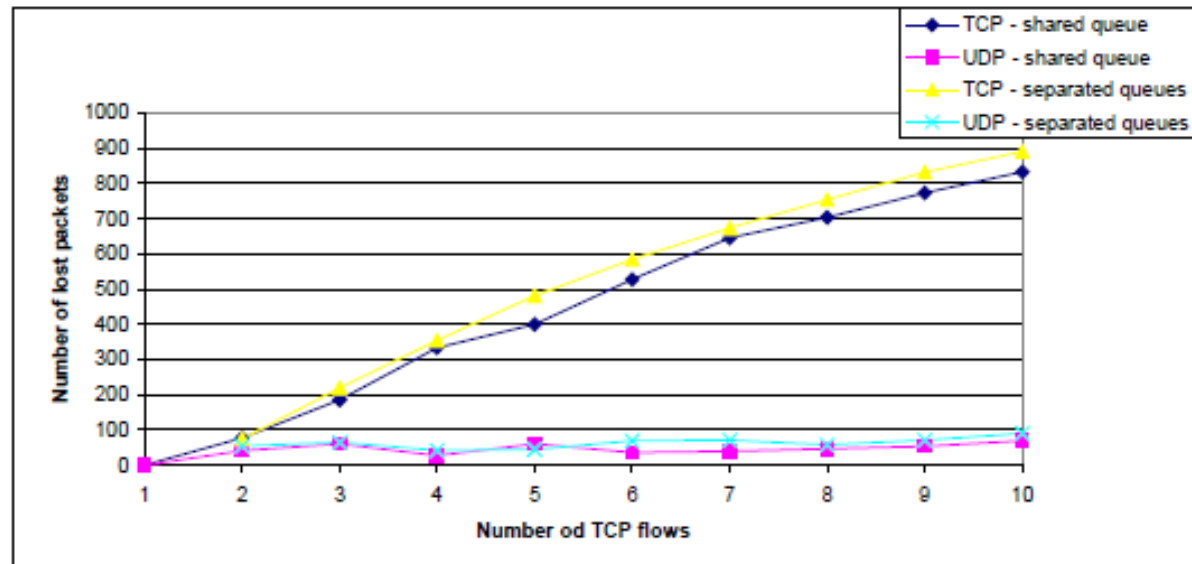

Figure 2. Number of received TCP and UDP packets for both simulation scenarios

Queue size [packet]	60
Each virtual queue size when traffic was separated [packet]	30
Bit rate of CBR source [Mbit/s]	1
Version of TCP	SACK
Packet size [B]	1000



UDP and TCP coexistence

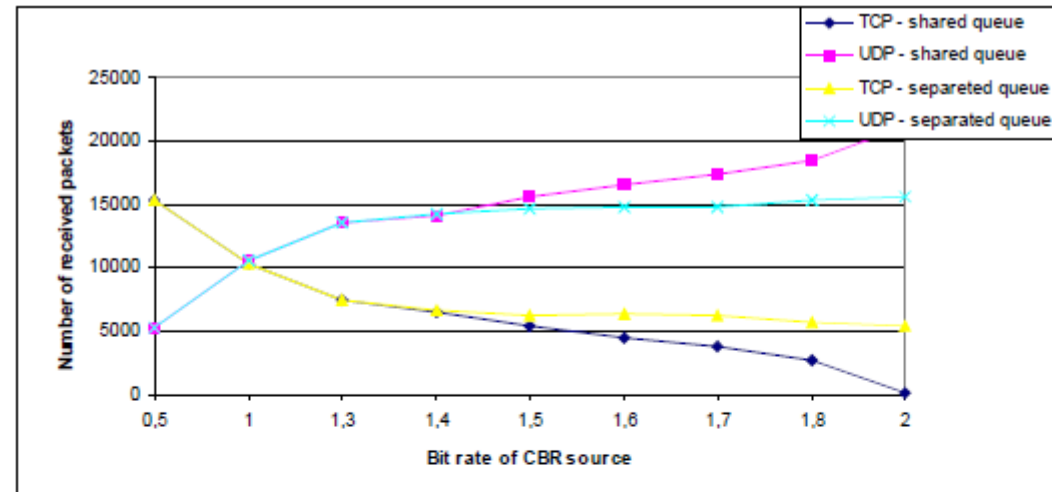
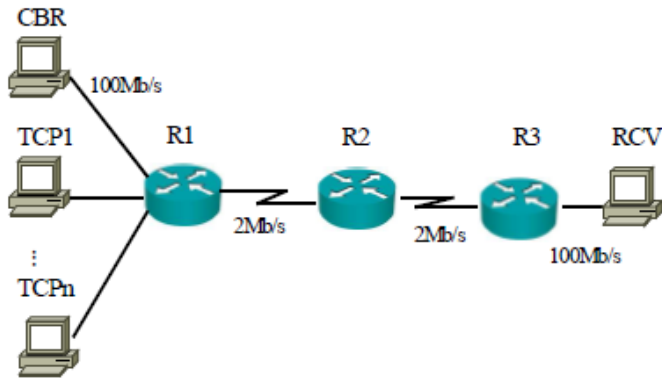
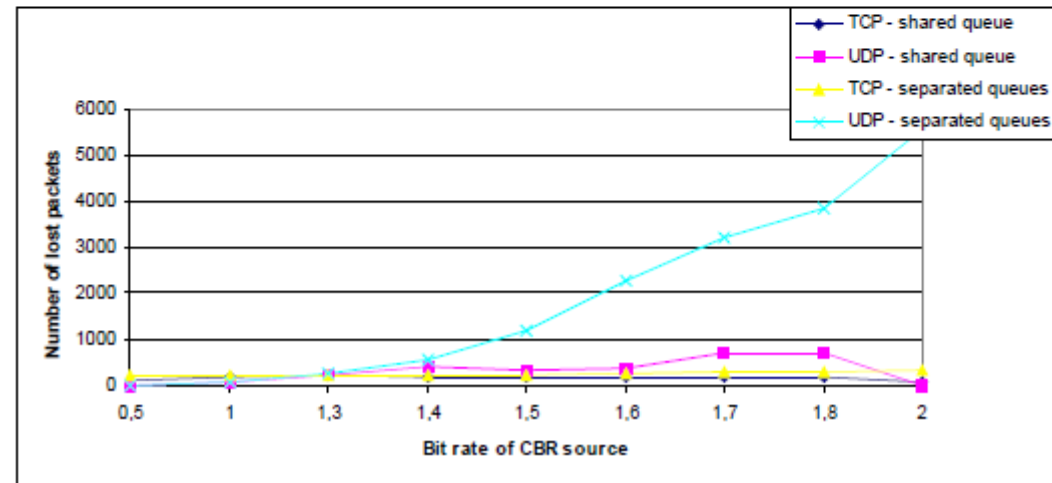

Figure 4. Number of received TCP and UDP packets for both simulation scenarios

Queue size [packet]	60
Each virtual queue size when traffic was separated [packet]	30
Bit rate of CBR source [Mbit/s]	1
Version of TCP	SACK
Packet size [B]	1000



IPTV: Reliable UDP (R-UDP)

- ❑ Sent in multicast UDP to the SetTopBox
- ❑ Losses found
 - Losses information sent in unicast UDP (packet sequence numbers)
 - Retransmission sent in unicast UDP
- ❑ Buffer in the application
 - Can go up to 8 sec (normal is 1 sec)
 - If retransmission arrives before play-out time, it is included in the play-out
 - STB in places with real-time visualizations (such as football games)
 - Very small buffers

IPTV: Instant Channel Change (ICC)

□ Normal channel change

- Multicast join to the server, all routers will have to start sending the multicast flow
- Buffers have to fill to start the play-out (at the rate of the multicast flow)

□ ICC

- Parallel to the multicast join to the server, there is a message to the distribution server
- This server maintains the last 8 sec of all channels
- Sends by unicast stream the latest information at the fastest path rate
- Fills the buffer more quickly and play-out the video (40 msec)

- When multicast process is done, normal multicast will be received

Bibliography to study

- J. Kurose, K. Ross, "Computer Networking: A Top-Down Approach", Addison-Wesley, 4th Edition
 - Chapter 3 "Transport Layer"